

Wire Book
of
D119
F-PPZF

TITLE

COVER

PAGE

0.0

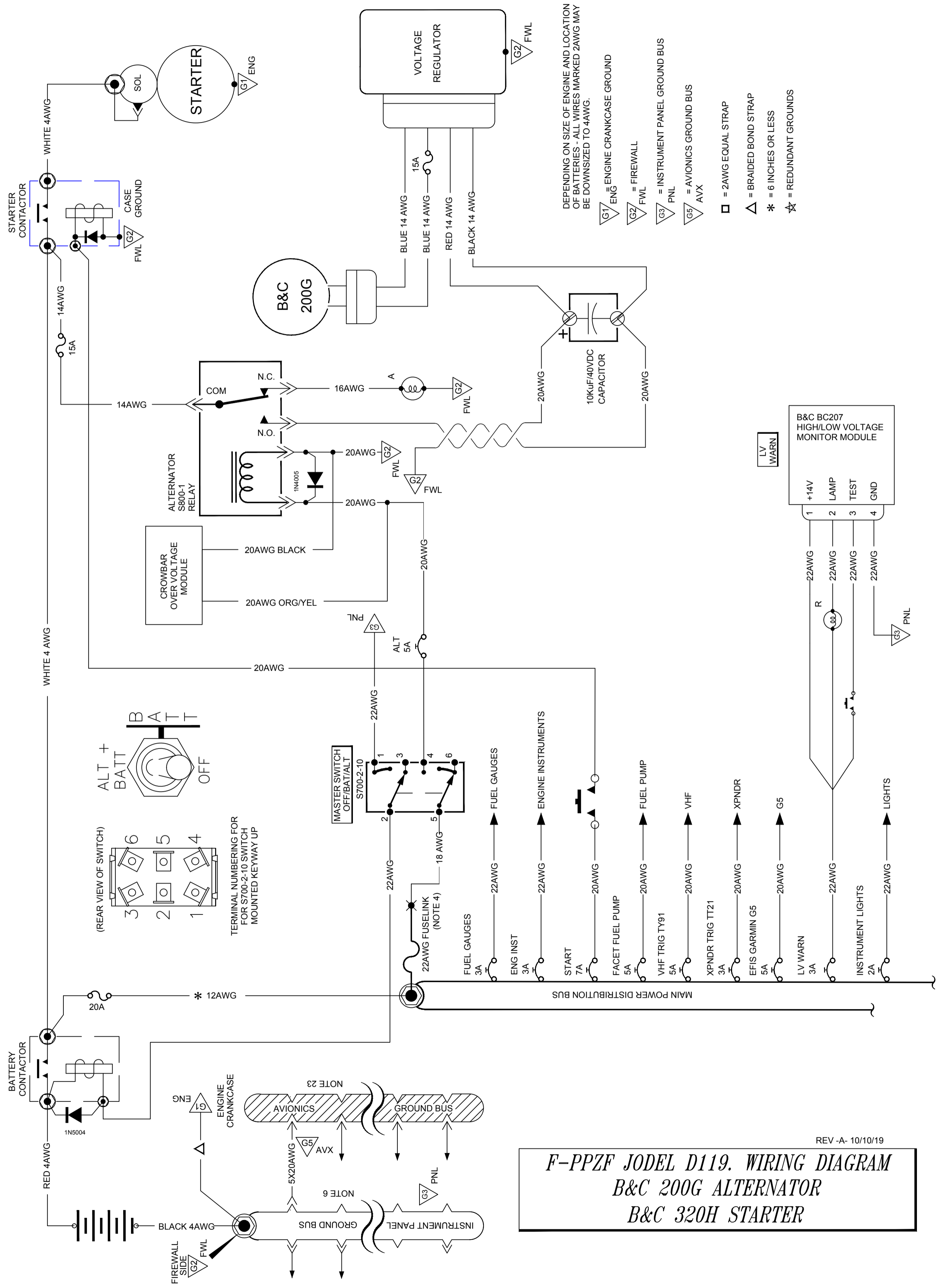

REV -A- 10/10/19

F-PPZF JODEL D119. WIRING DIAGRAM
B&C 200G ALTERNATOR
B&C 320H STARTER

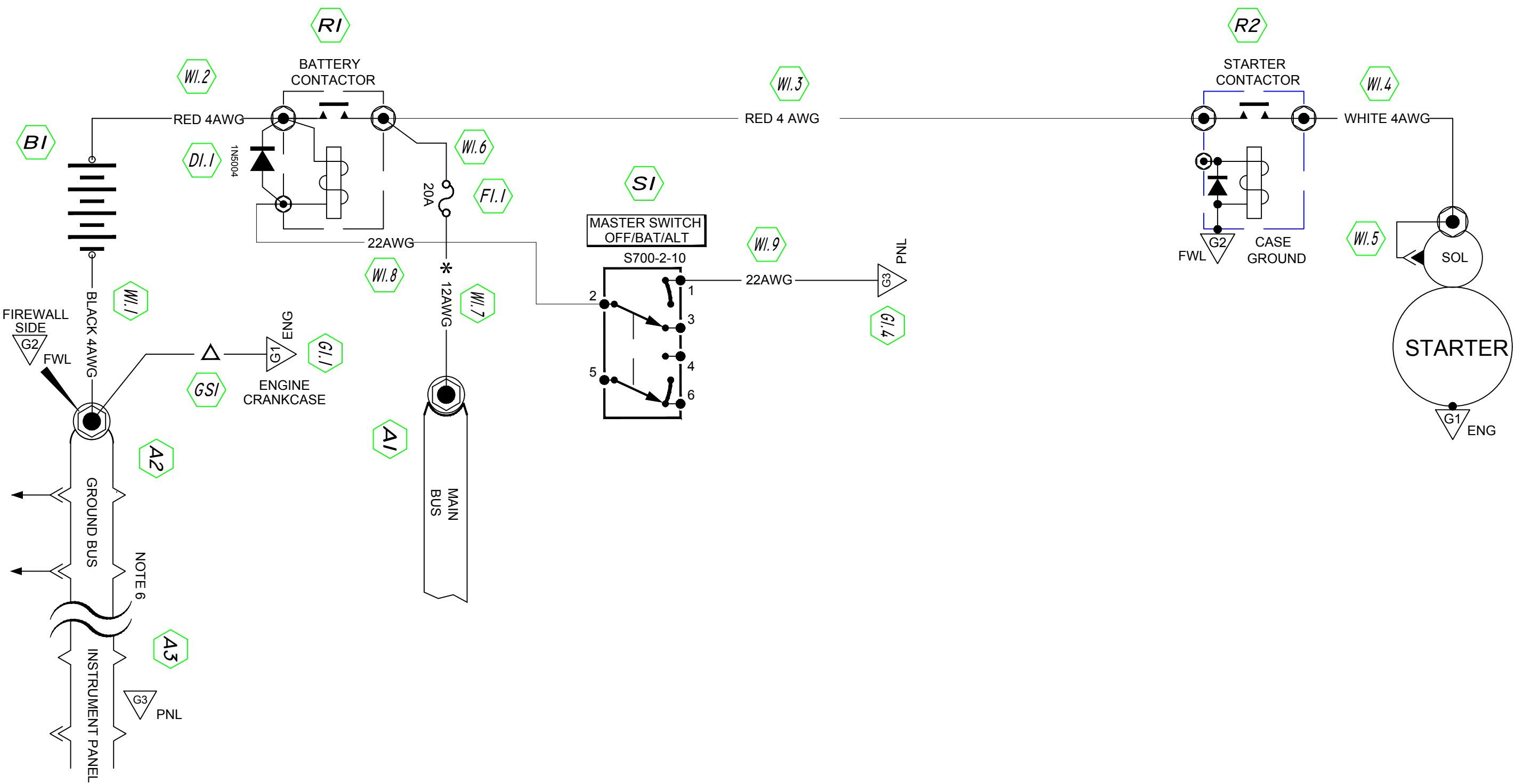
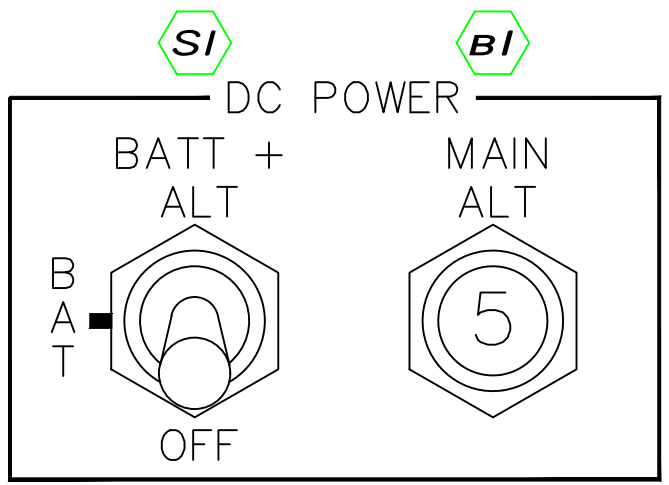

TITLE

BATTERY

PAGE

1.2

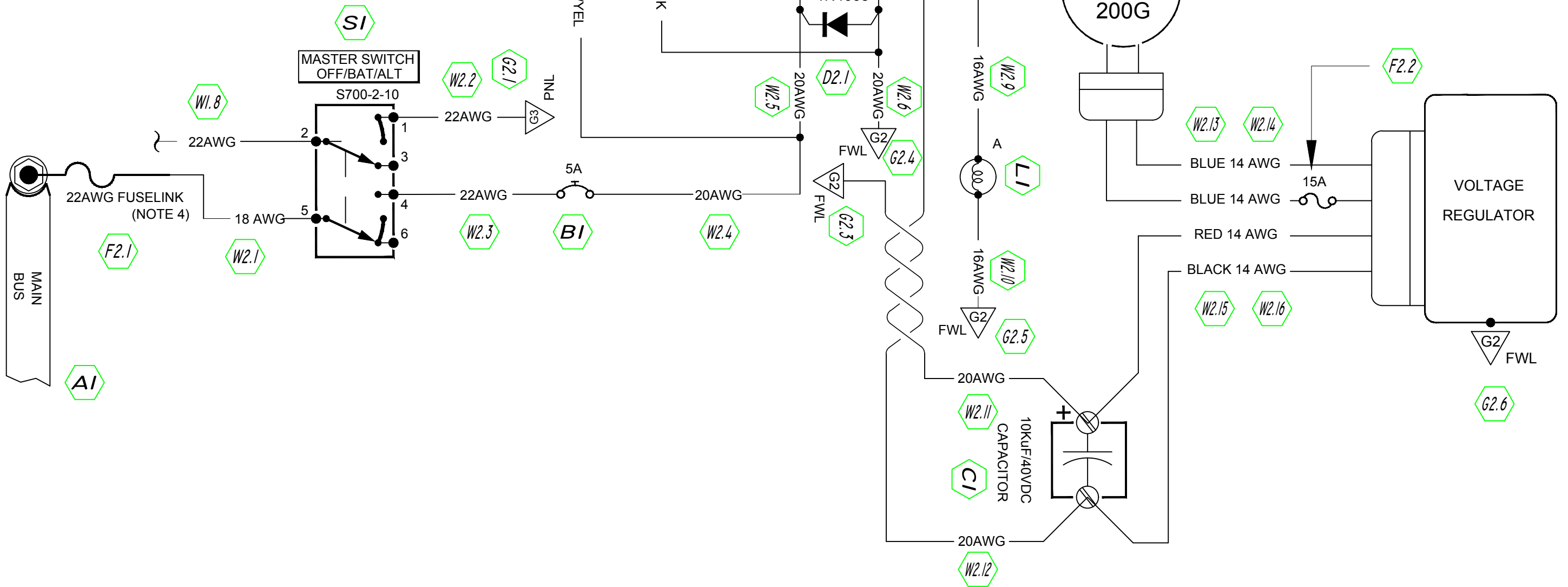
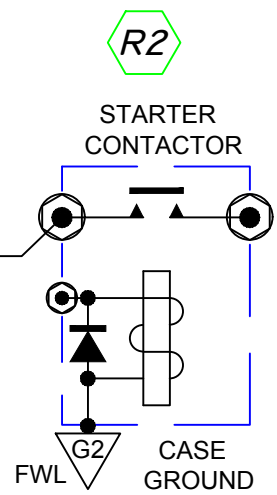
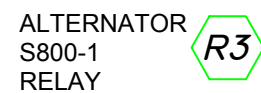
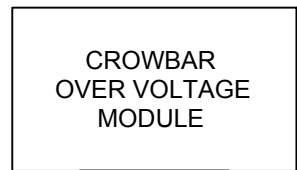
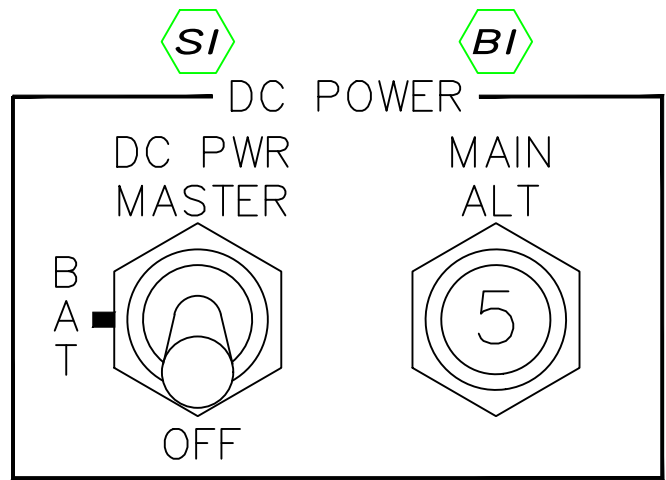

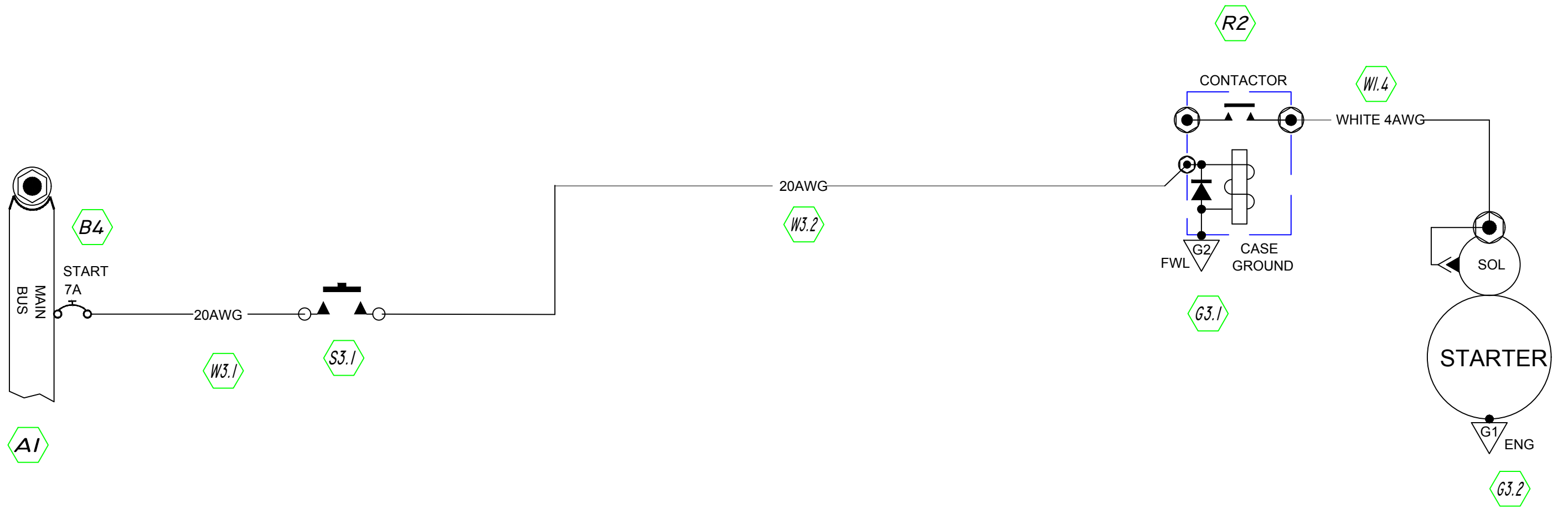
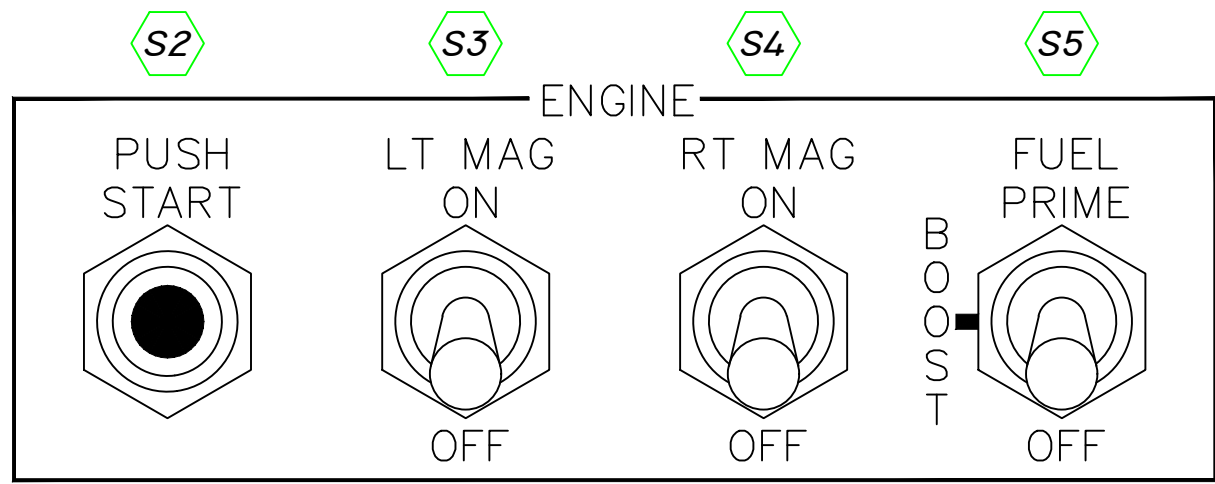

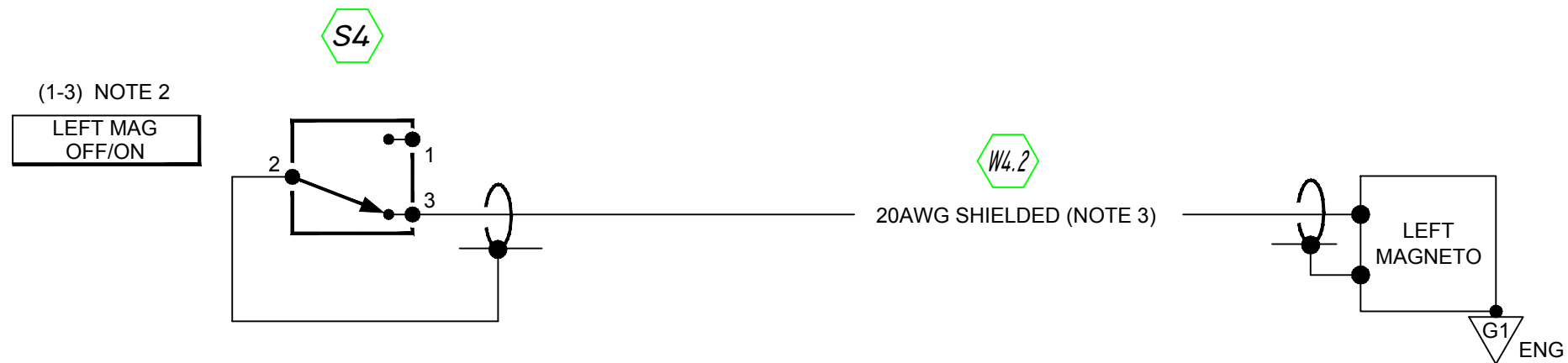
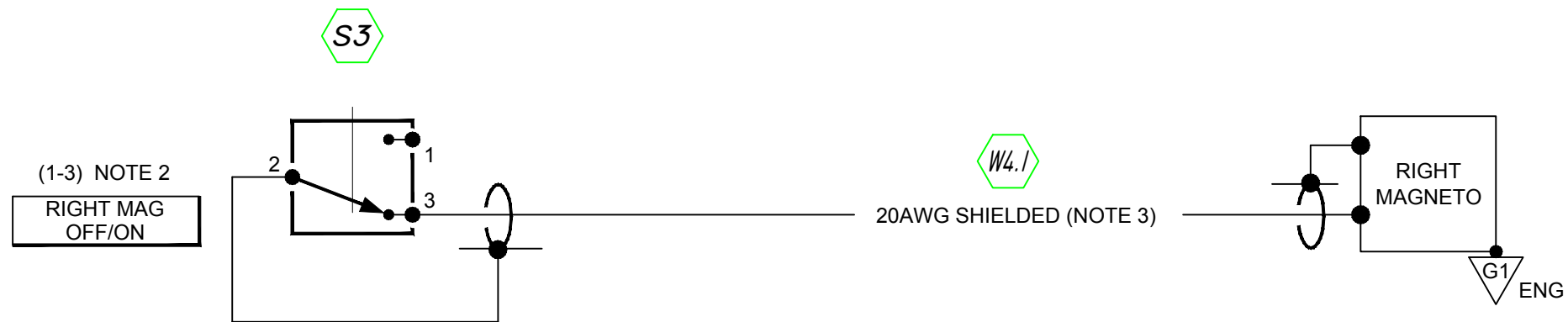

NOTES

1. THIS GROUND TERMINAL IS USED TO KILL MAGS BY WAY ENGINE GROUND SECURED THROUGH SHIELDS ON IGNITION CONTROL WIRES. DO NOT CONNECT THIS GROUND TO ANY OTHER CONDUCTORS IN THE COCKPIT.
2. THIS GROUND IS STRAPPED TO THE "R" MAG TERMINAL ON MAGNETO EQUIPPED ENGINES ONLY. DO NOT USE THIS TERMINAL ON THE ROTAX ENGINE INSTALLATION.

WARNING LIGHTS

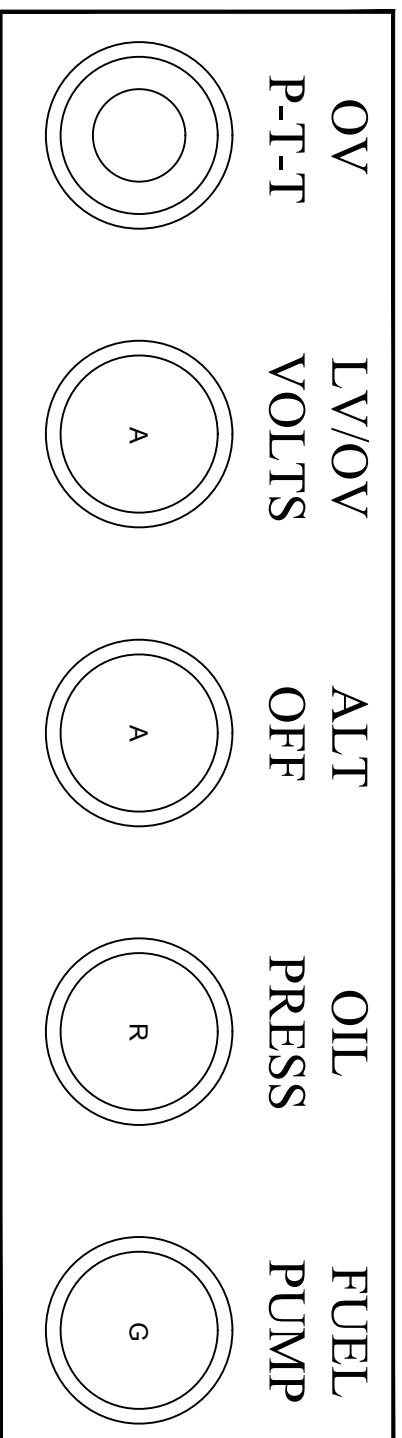

S6

L4

L1

L2

L3

B2

B3

B5

B5

B6

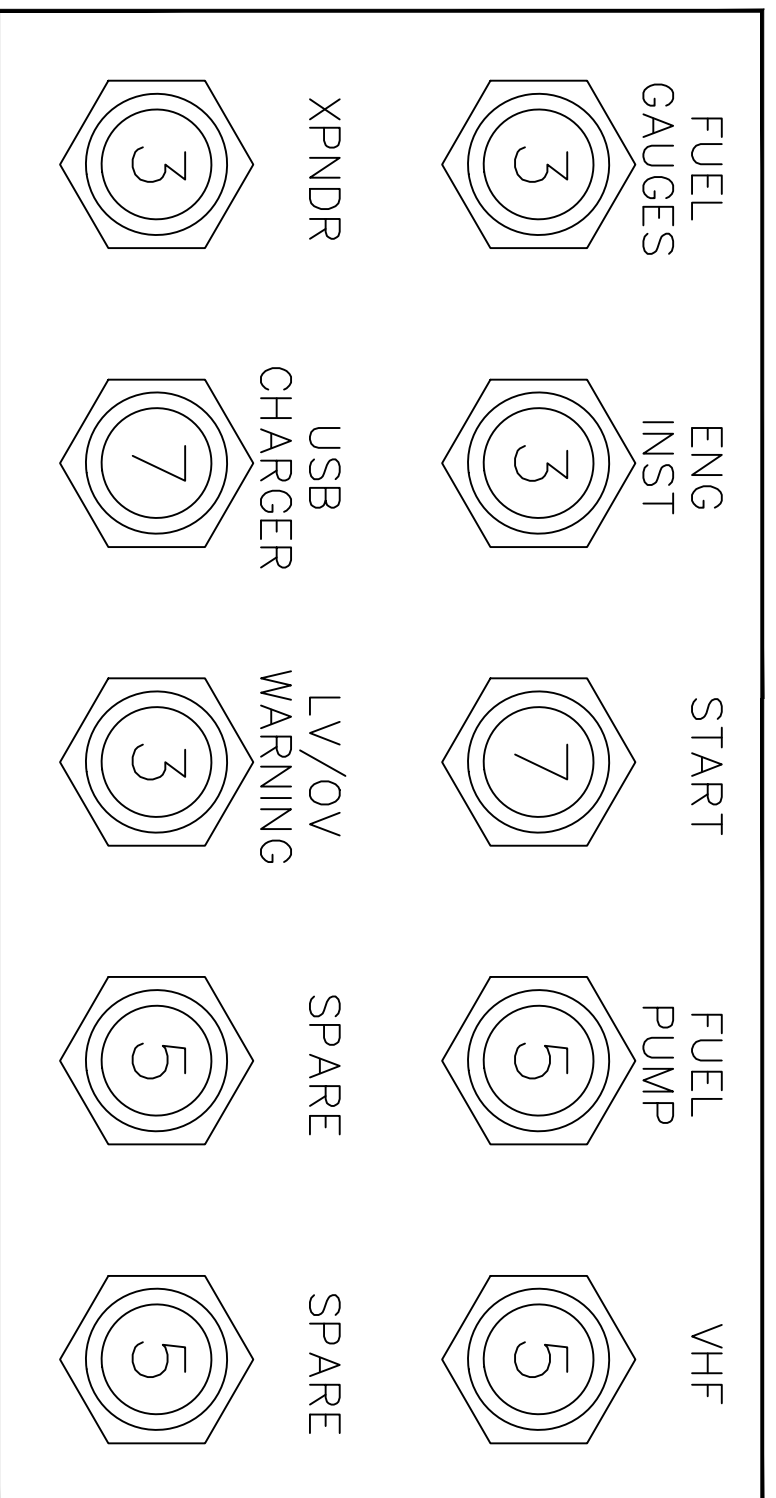

B7

B8

B9

B10

B11

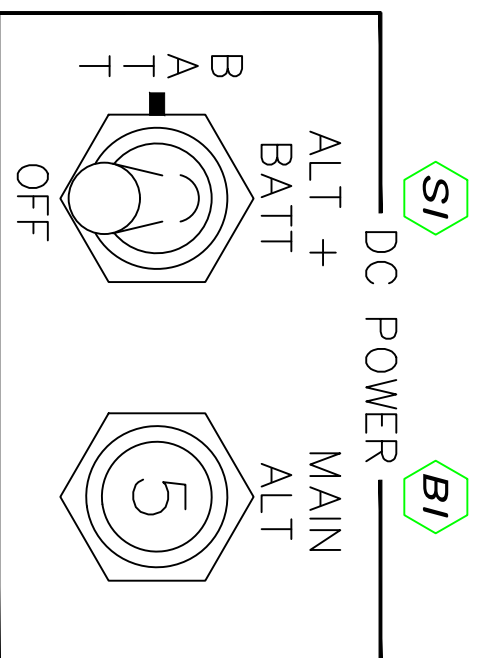

S1

B1

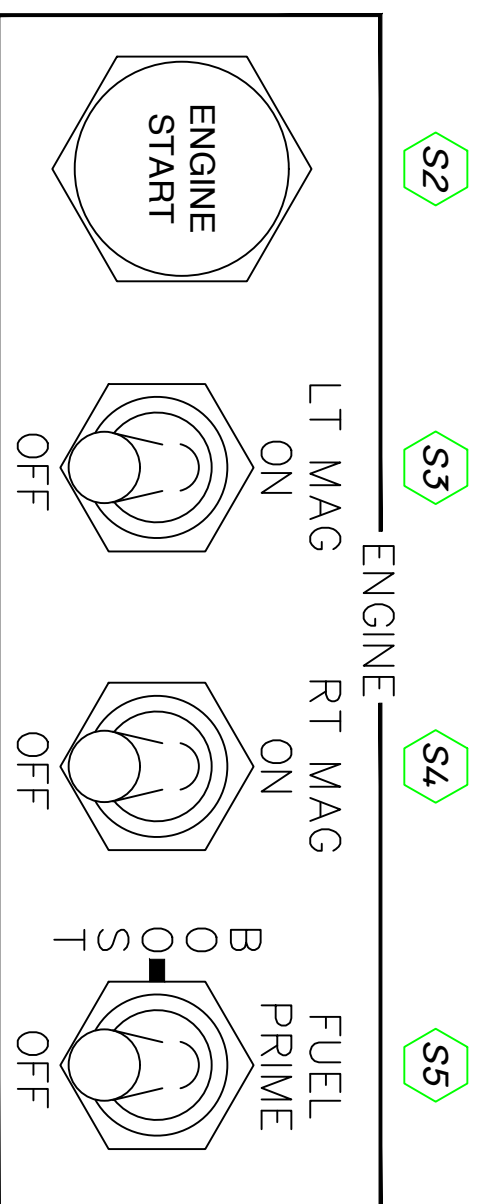

S2

S3

S4

S5

POWER BUS LOAD ANALYSIS

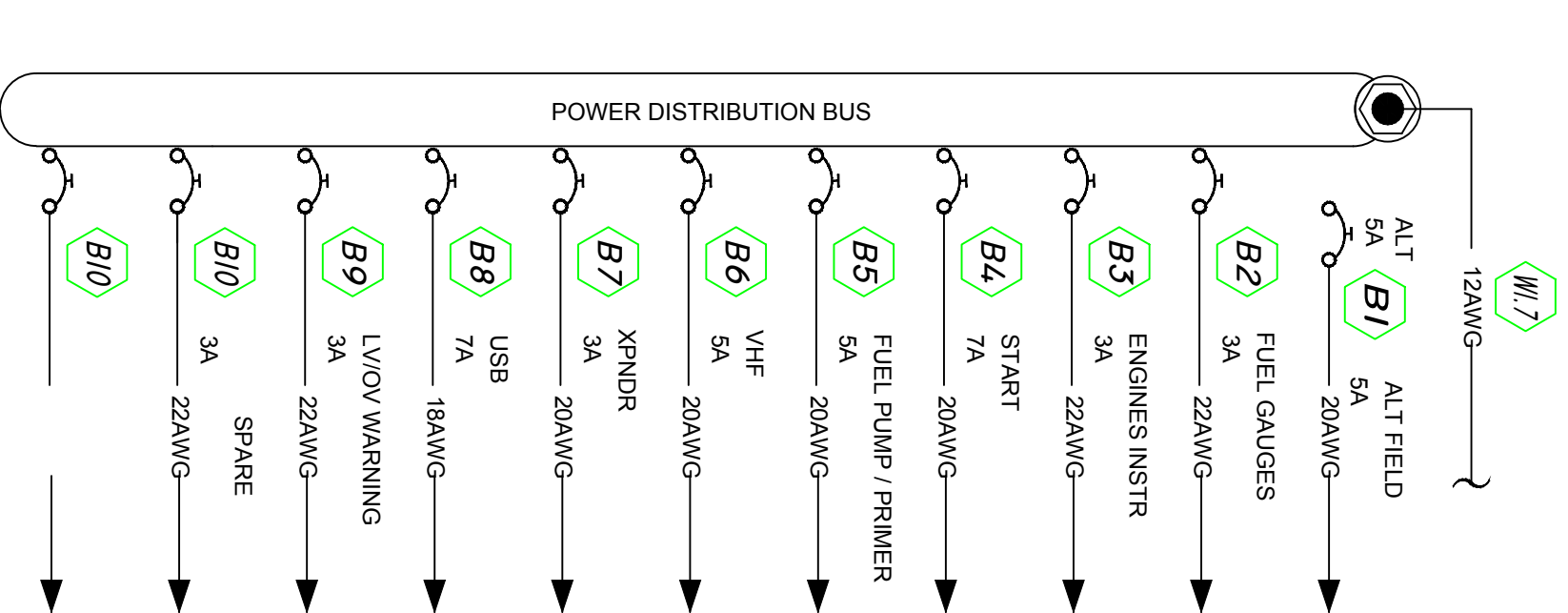

ACCESSORY	PRE-FLIGHT	TAXI	TAKEOFF CLIMB	CRUISE	APPRCH TO LDG	EMERG
ALT FIELD	0.1	0.1	0.1	0.1	0.1	0
FUEL GAUGES	0.1	0.1	0.1	0.1	0.1	0
ENGINE INSTRUMENTS	0.1	0.1	0.1	0.1	0.1	0
START	0	0	0	0	0	0
FUEL PUMP / PRIMER	0	0	1.6	0	1.6	0
TRIG TY91	0.2	0.2	0.2	0.2	0.2	0.2
TRIG TT21	0.4	0.4	0.4	0.4	0.4	0.4
USB	2.0	2.0	2.0	2.0	2.0	0
LV/OV WARNING	0.1	0.1	0.1	0.1	0.1	0.1
SPARE	0.1	0.1	0.1	0.1	0.1	0.1
TOTAL	3.1	3.1	4.7	3.1	4.7	0.8

W1.7

B1

ALT FIELD
5A

B2

FUEL GAUGES
3A

B3

ENGINES INSTR
3A

B4

START
7A

B5

FUEL PUMP / PRIMER
5A

POWER DISTRIBUTION BUS

B6

VHF
5A

B7

XPNDR
3A

B8

USB
7A

B9

LV/OV WARNING
3A

B10

SPARE
3A

B10

SPARE
22AWG

A1

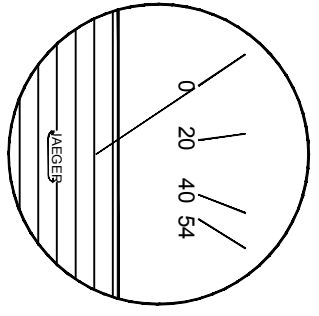
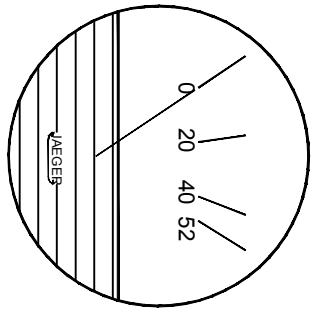
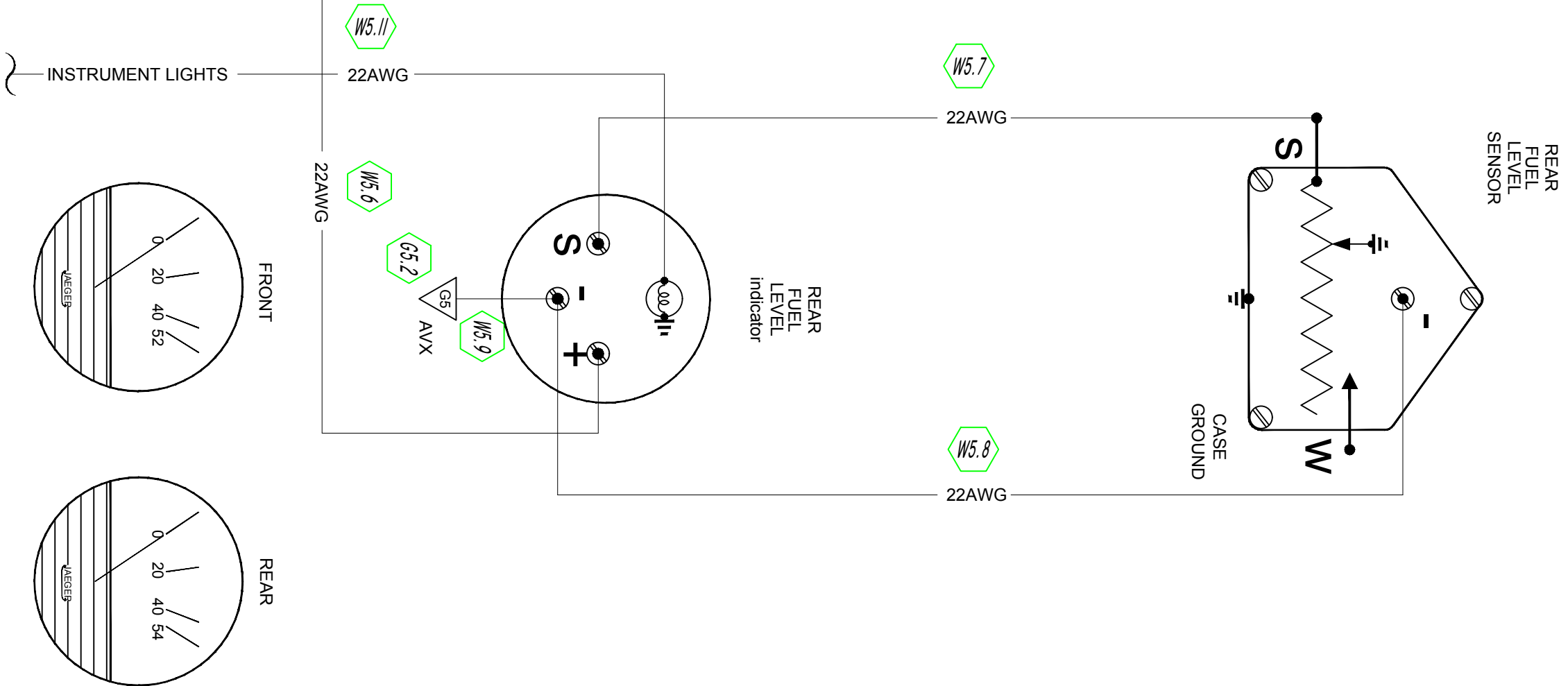
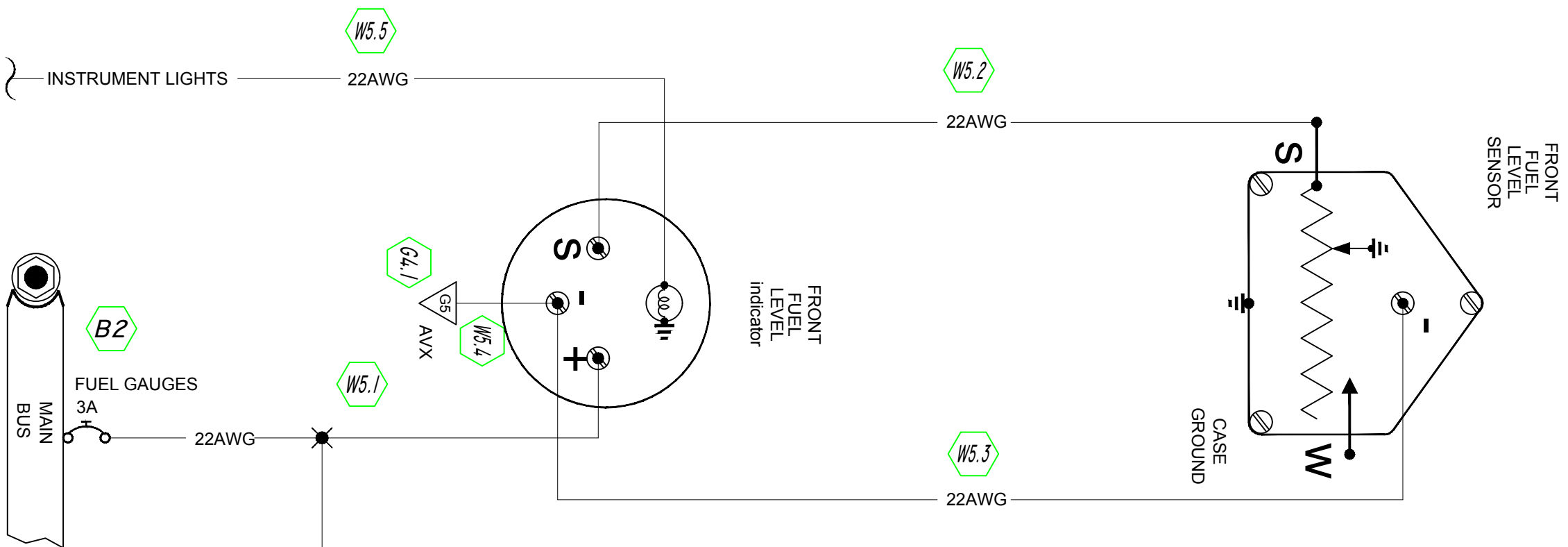

TITLE

PAGE

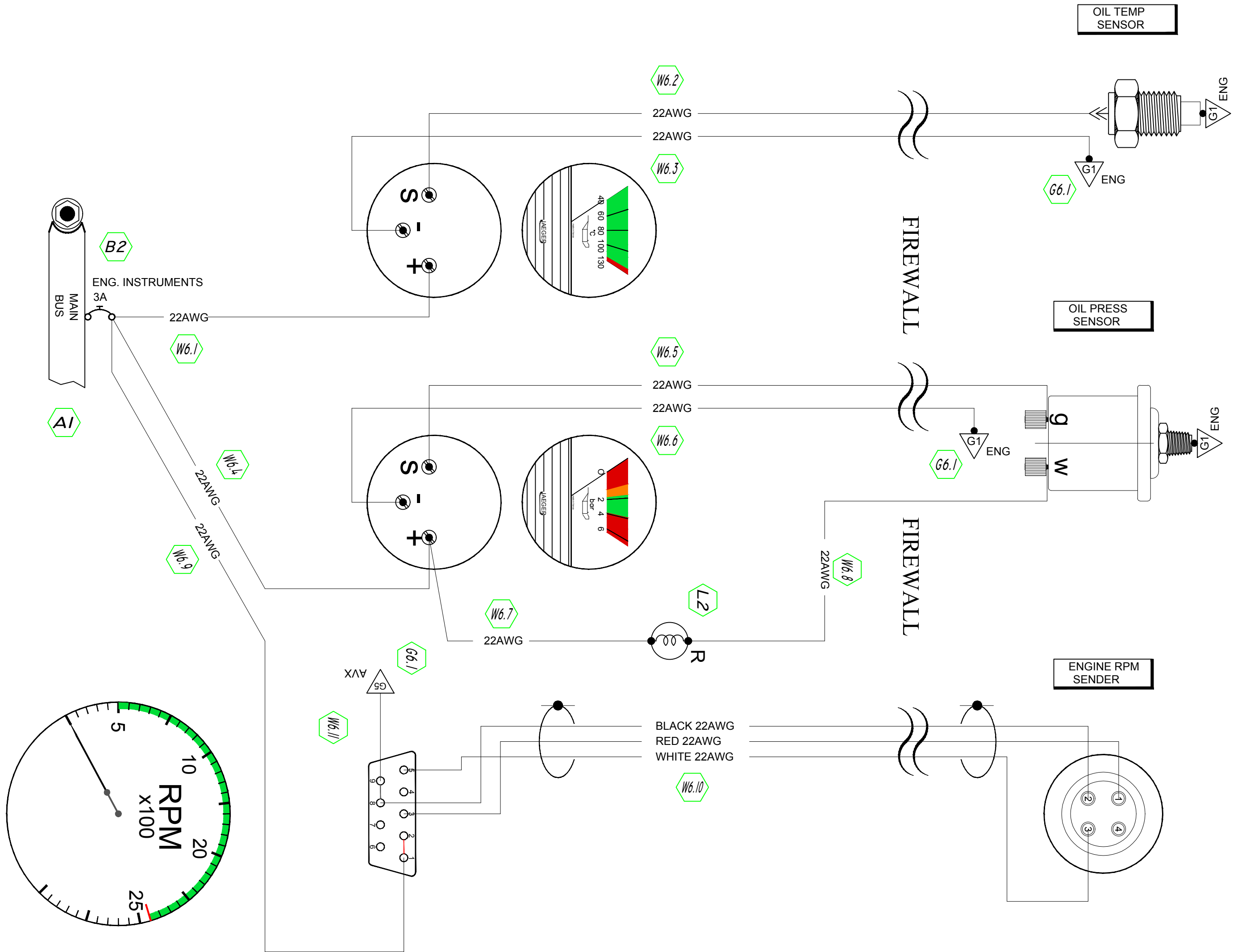

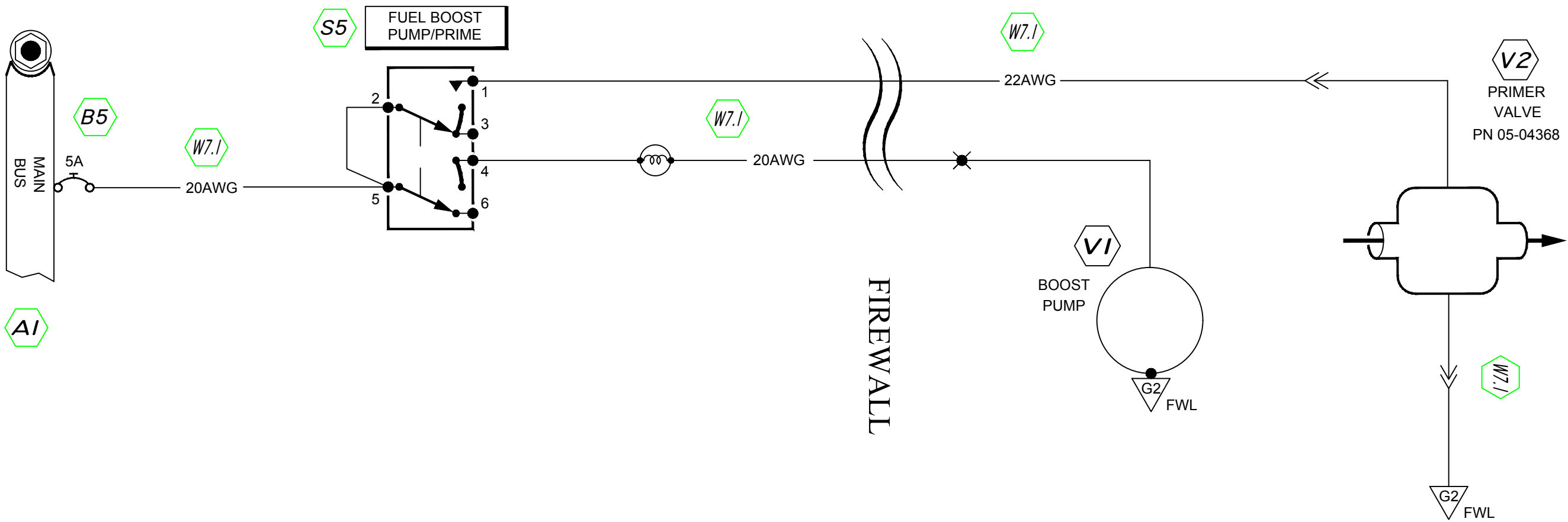

TITLE	
PAGE	7.0

FUEL PUMP & PRIMER

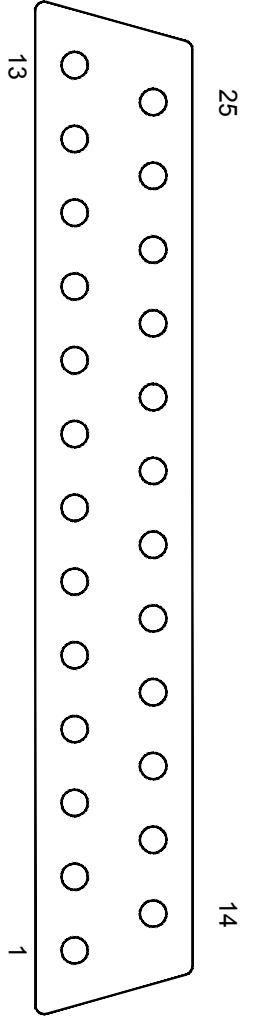

TMAP 1A	3
TMAP 1B	4
TC90 POWER	12
POWER ON	13
GROUND	9
Aux In	20
INTERCOM PTT	17
PTT 2	14
MIC 2 In	21
GROUND	22
PTT 1	15
MIC 1 In	23
Phone Out	11
Phone Ground	10
DC Power	24
DC Power	25
Ground	19

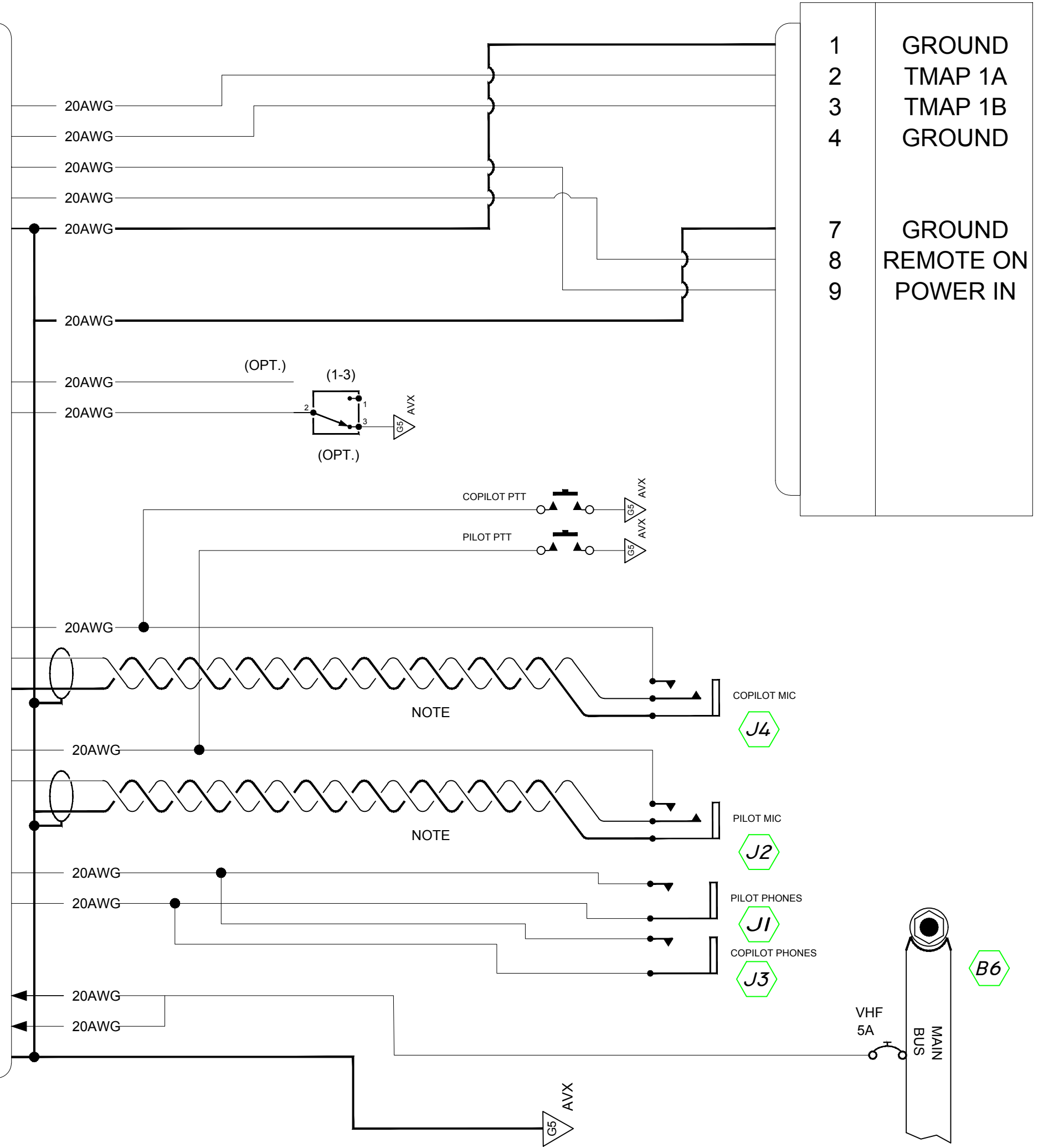

1	GROUND
2	TMAP 1A
3	TMAP 1B
4	GROUND
7	GROUND
8	REMOTE ON
9	POWER IN

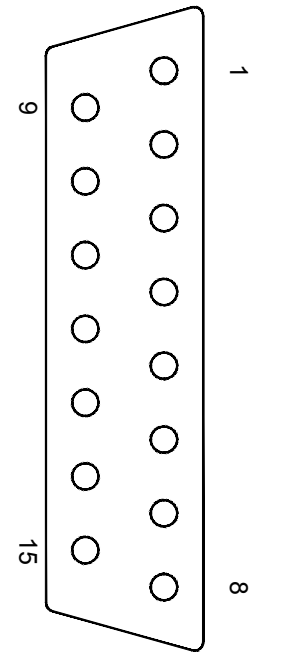

NOTE
twisted screened pair of 20 AWG wires
with the screening connected to ground at radio end

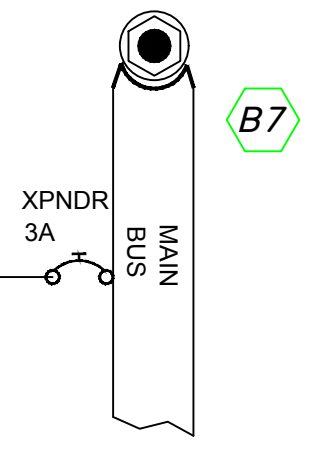
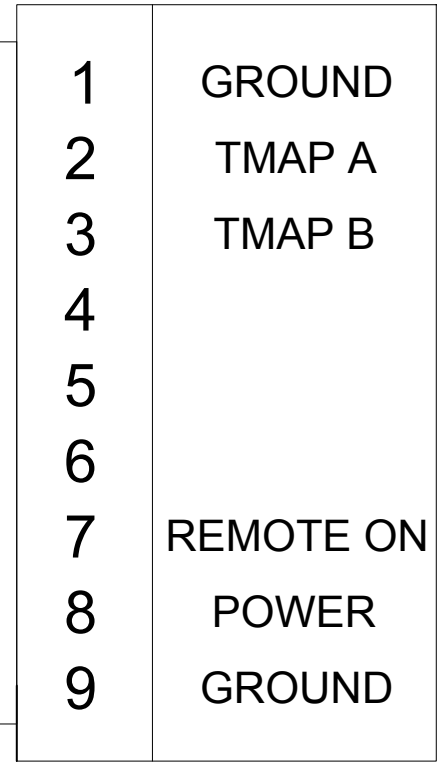
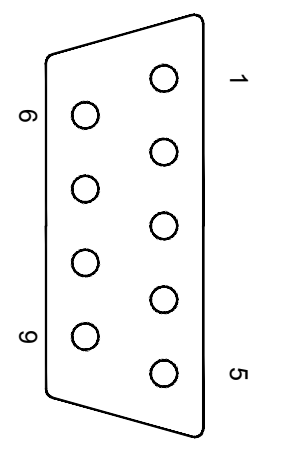
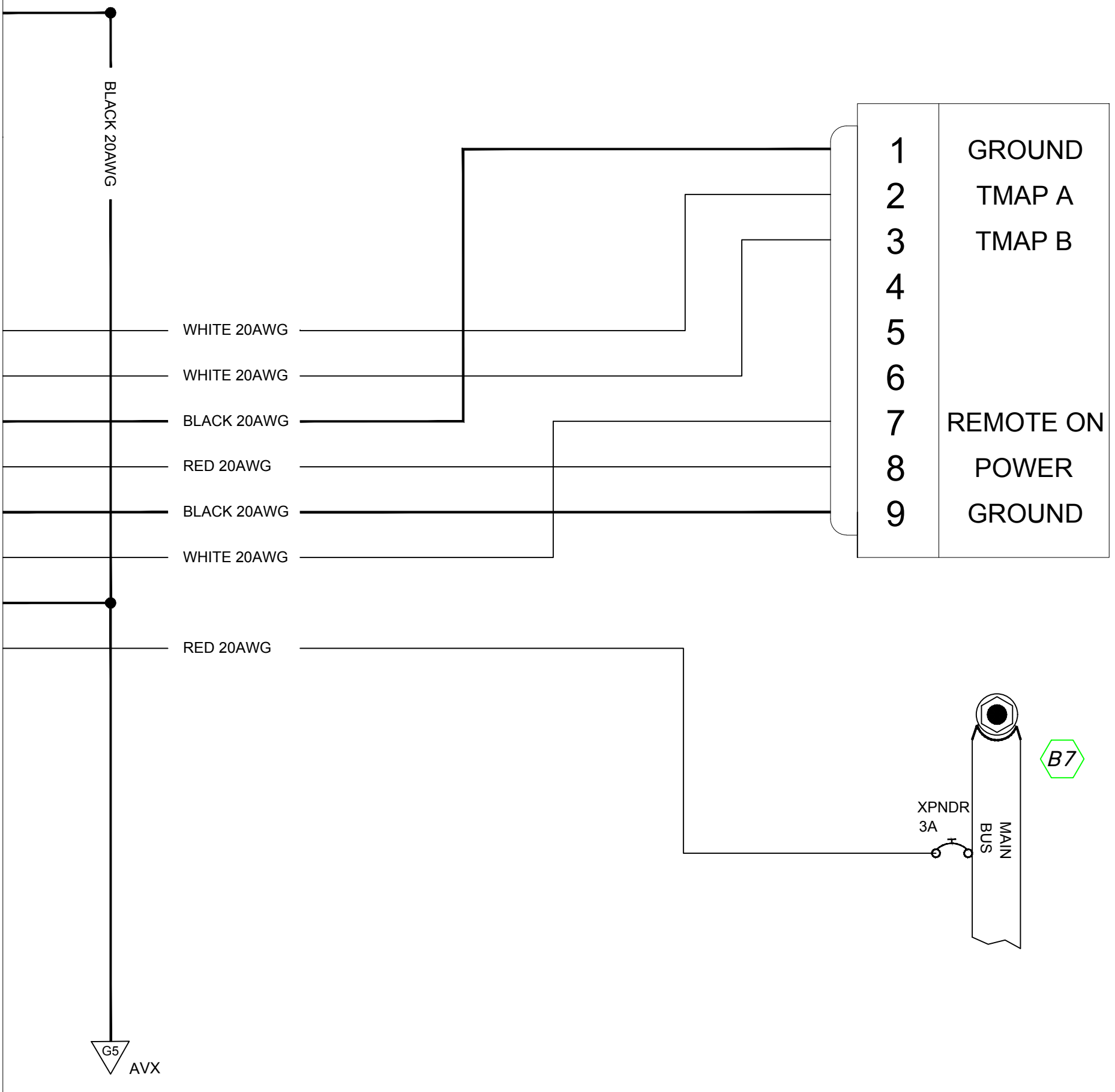
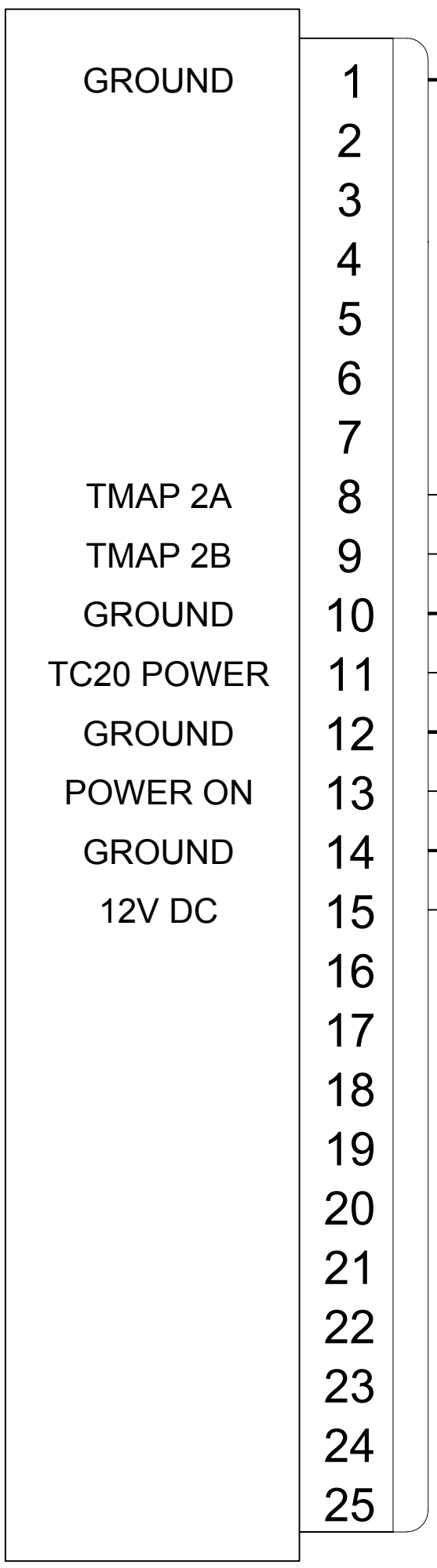
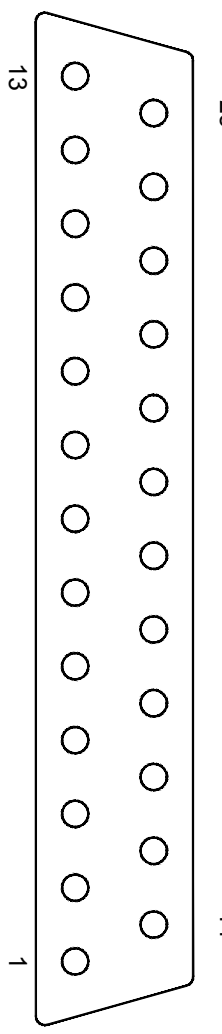

B7

NOTE
use 20 AWG wire for the whole harness

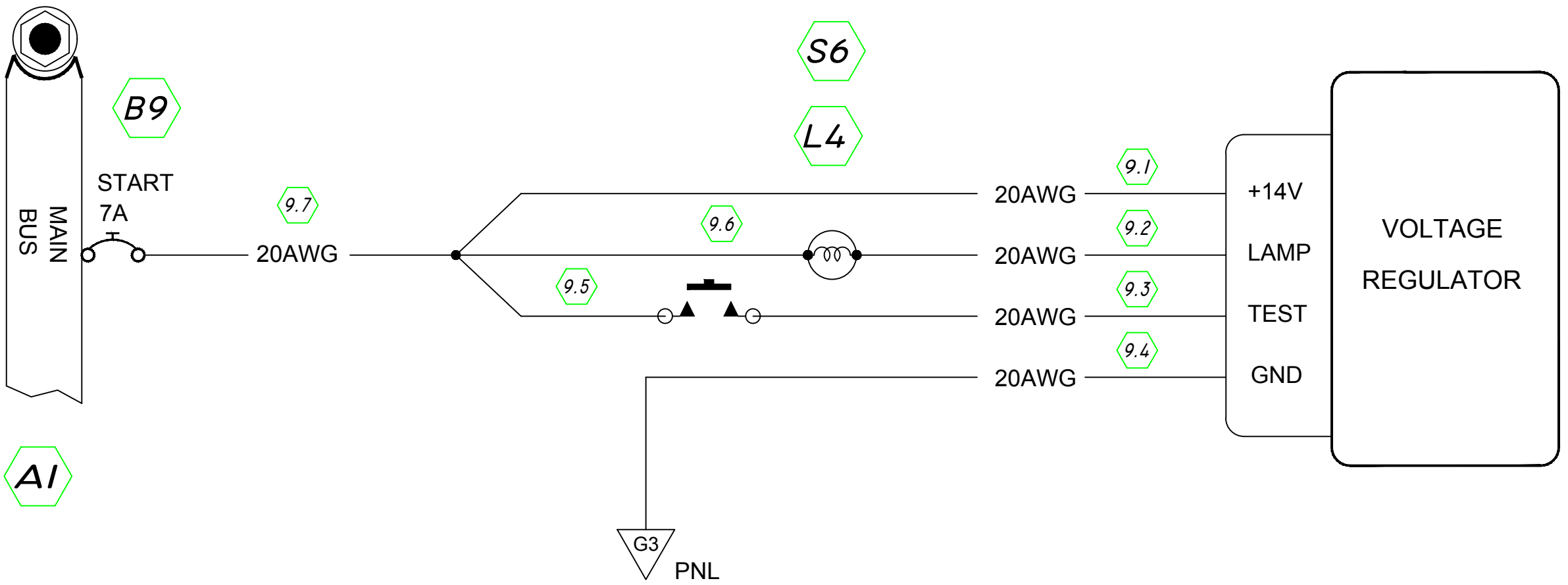

TITLE	
LVI/OV WARNING	
PAGE	9.0