

# **Rotax Engine Troubleshooting and Maintenance from Experience. Updated April 2021**

By Bud Yerly,  
Custom Flight Creations, Inc.

Now that I'm retiring, and I no longer keep a full time A&P employed, I don't care to go back to school to maintain a Rotax certification. I want to pass on my troubleshooting experiences to all others to keep their Rotax running well. I have trouble shot many an engine and assisted many others, talked with many mechanics/owners/operators sharing their problems and solutions over the last 19 years and this document is as complete a guide on what we all have learned as a building and repairing community in our trials and tribulations. This guide is submitted so that our new and secondhand Rotax powered aircraft owners may avoid our painful learning experiences. This is an extensive update to my original 2016-20 troubleshooting guide of the Rotax 91X series engines.

The official Rotax troubleshooting guide is basic (except for the 914 Turbo Control Unit section which is darned adequate) and many of you shade tree hangar mechanics have spent hours over the years on the internet studying, asking and sharing your particular Rotax engine problems. We have all learned the hard way, through study, experimentation and just plain dumb luck, some of the techniques and maintenance checks necessary to keep our Rotax engines in tip top shape. In 2015 I was surprised at the number of recurring questions and diagnostic problems I thought we builders and owners had already solved in the older (Pre 2005 912S and 914 engines). Recently many new owners of used experimental and LSA aircraft are having the same issues we old heads have had in the past, so most of this document pertains to the carbureted engines and is geared toward our current owners and LSA/second-hand owners who may be unfamiliar with the Rotax troubleshooting and servicing. The new carbureted 912S/914 engines contain many improvements over the pre 2000 engines, but the troubleshooting techniques stated here still apply. Alas, I have no real experience with the 912iS/915 fuel injected engines other than to take it to the dealer to assist in the electronics troubleshooting and overheating issues Rotax failed to address. There have been many problems with the fuel map in the 912iS engine as it runs in full lean mode even during taxi, so it runs hot on the ground and will overheat even during any short high power ground runs. Most of my work with the 912iS has been with folks having issues with the now automatic "fuse box" of the dual alternator electronic switching system and test flying with owners to find the power they are used to while still in an "ECO" mode in these fuel injected engines. I have yet to recommend installing one of these engines until the bugs are worked out, but I feel Rotax has finally got a handle on most problems and to their credit are rapidly solving problems with cooling and electrical A to B load switching of the fuse box. The main issue is the fuel mapping in flight and how to prevent overly leaned engine issues robbing the pilot of power. A common complaint is I'm going slower than with my 912S. The new iS series has a designed power mode that goes abruptly to eco mode as the throttle is retarded below 97%. One must find the sweet

spot or power drops abruptly with the fuel flow. More will follow on the appropriate operational techniques to improve pilot performance and propeller matching. This new injected series engine will be quite efficient and powerful negating moving toward any of the so called big bore engines. As the turbocharged 915i comes on line, we are finding this powerful new Rotax has its teething issues also but is more refined and much more comfortable for the pilot when using a constant speed propeller.

Historically, troubleshooting guides cover engine components first, then crankcase mechanical, and finally operational symptoms of trouble. So, this guide will be no different. However, I have included an expansive phase of flight section of engine related problems. It is broken down into ground, flight, and descent/landing phases where the most common problems or questions arise. Some photos, and a handy index is included at the end of the document.

Full disclosure: My personal 914 is a 1997 engine and is quite old. Every SB, SI, SL or note seems to apply to my engine. If the SB said there may be a problem, there was. So please pay attention to the SB, SI list for your engine and join the Rotax Owners Forum. Remember, advice that's free is often times worth what you pay for it, so get smart on your engine, learn the aircraft and engine systems, and be informed. Forums and even this document are suggested actions and guides for where to start. If I do say myself, this troubleshooting guide is quite good, just wordy, as I explain why or what is happening as well as how to fix it. Reviews have been quite positive but complaints of no pictures or drawings have been addressed where appropriate.

Finally, a note of advice. Most pilots want the maintenance checks completed just before the flying season starts and they are in a rush to get servicing done. However, nothing good happens to an aircraft that sits over winter or during extensive maintenance upgrades, so consider doing your upgrades at the end of the season so you have time to fix things right, then test fly your upgrades and prepare your airplane for storage properly. In Section 1/oil System Problems I include a maintenance plan to return your aircraft to flying status that is short and sweet. When the engine or airframe gives you some problems, scan through this document again, and solve the problems quickly and get on to your flying adventures.

## **Section 1**

### **Mechanical Systems and Troubleshooting**

#### **Starters:**

Starters are re-buildable and quite reliable. The older low torque starters do need some attention after a few hundred hours as dirty armature decreases cranking RPM and the engine won't start if it isn't cranking fast enough.

**Trouble:** I have had two starters that were full of oil/grease (and brush dust) covering the armature contacts and making intermittent or weak cranking. The battery was changed, terminal wires checked but alas the poor starting problem persisted. Always start by checking the electrical connections. A loose #4 cable terminal slows cranking significantly. If the cables and solenoid are good, then we go to the mechanical.

**Culprit:** The front seal wore out at about 3-400 hours and the bearing grease got on the armature and made a mess of carbon dust and grease shorting/decreasing starter armature continuity. This seal also keeps oil from the sprag clutch housing area from getting into the starter. The performance of the armature was so diminished that cranking became somewhat slow or intermittent forcing the need for a rebuild. The starter case is well sealed, so no grease or oil was evident on outside of the case. However, the starter barely made 250 rpm during cranking and by just watching the blades spin on start, I knew it was not going to fire.

**Warning:**

*Poor starter performance may induce a kickback in either the 912,912S and 914. This will wear your sprag clutch rapidly. The replacement of the sprag clutch requires removal of and a tear down of the rear of the engine. Not a fast or cheap operation.*

**Maintenance Service of the starter:** In most cases remove, disassemble, properly clean, and buy \$100 worth of seals and brushes from the dealer and rebuild the starter. Make a note every 5 years/300 hours to pull the starter and check the shaft end fore and aft movement. If the shaft moves in and out over 0.3 mm, I guarantee you will have a problem soon. If replacing your old starter with a high torque (AP style or the new SkyTec hi torque starter) you will be surprised at the increase in starter revolutions and the improvement in starting nearly eliminating kickback. With the Rotax starter, you may need to cut a couple tabs off the housing to fit past our Rotax engine ring mount used in the XS Europa and many other aircraft. (In Florida, I never needed the high torque starter, even on the 912S, a low torque starter was sufficient, provided the starter and battery are operating properly with 12.5 volts minimum for cranking voltage. However, if the battery voltage was barely at 12 volts, starting was suspect. The new high torque starter works great on a slightly weak battery only indicating 12 volts (or slightly lower.) A turbo oil-soaked or hot or flooded engine also cranks far quicker. The Classic Europa and many other aircraft that do not use the Rotax engine ring mount support, may have clearance problems so measure first or the longer starter as it will require significant changes to the engine frame supports on some aircraft.



SkyTec high torque is the same size as the Rotax high torque and the tabs are cut off. Cheaper too.

**Ignition:**

**Trouble:** While tuning the carbs on an annual I leaned on the ignition module and the engine began running rough. Grounds were OK. I moved the ignition red wires between the ignition box and plug, and the engine quit. NOT GOOD!

**Culprit:** The red power leads from the stator had broken right where they made a 90-degree bend between the ignition module and the plug. This 90-degree bend is standard on the Rotax factory 2004 912S engine and the 1999 914 engine and newer. The break occurred 3/8" or about 10 mm behind the crimped pin inside the insulation and was invisible to the naked eye. The wire pulled right out of the insulation on disassembly. The wire was clean except at the break where it clearly cracked and failed over time. I have also had engines that would not turn off because the grounding wire failed between the plug and ignition module. (OLDER ROTAX ENGINES GENERALLY WERE NOT REPAIRED UNDER SB 912 013 OR 914 016, WHICH CALLED FOR OWNERS TO RENEW AND REPLACE THE IGNITIONS. FRANKLY, WHO HAD THE MONEY TO REPLACE THE WHOLE MODULE!)

**Maintenance:** CHECK YOUR WIRES ON THE ANNUAL CAREFULLY. Make sure the leads are secure and suspect any tight wire bends. Do not zip tie directly to the wire insulation as the insulation is weak and a zip tie cuts through the soft rubber insulation over time. Use heat shrink to protect the wire, and if needed, secure wire ties over the heat shrink to secure the plugs from vibration. ALTHOUGH YOU MAY HAVE A NEWER ENGINE WITH SUPPORTS FOR THE IGNITION PLUGS, CHECK THE WIRES AT THE BENDS ALWAYS, AS FATIGUE OF THESE WIRES IS A REALITY. Supporting the ignition wires is best accomplished by use of the new wire support brackets, but simply zip tying the plugs together then zip the plugs to the ignition box side will suffice on the older engines without the supports.

*Note: It is extremely rare for the solid-state ignition box to fail. Normally it is a ground or broken wire. Dealers change the box as finding and fixing the broken wire is time consuming and labor costs cannot be recouped and frankly, they don't make as much money, so it is not worth it for a dealer. If you have the time, swap modules, and isolate where the problem is. This is time consuming and a potential for more damage moving very old wires around. Now you see why dealers prefer to change the module...*

### **Coils:**

Intermittent rough mag check but good rpm drop even with new plugs installed.

**Culprit:** The coil has been on the engine ten years. The metal core material was corroded, and the plates were spilt apart slightly. The coil electrically ohmed out OK. The split steel plates running through the core reduced the coil output as the magnetic field was poor. I changed the coil, and all was well. The plug wire only screws into the coil ends, be sure to check the metal screw threads are secure and not corroded or twisted off and stuck in the wire.

**Maintenance:** Pay attention to your coils on the annual and 5-year check. Corrosion X or ACP50 helps prevent the unprotected steel from becoming a barnacle. If split ends on the core steel plates is present, you will have problems eventually. Normally, I keep a

new or serviceable coil on the shelf and wait until the coil causes a miss and then swap out the offending coil(s). Keep coil grounds clean.

### **Plug wires:**

Rotax plug wires are just copper wires with thick insulation. Rotax says change the plug wires at 5 years...NOBODY DOES!

**Maintenance:** These ignition wires last at least 10 or more years provided there is no exterior wear to the wires. During the 5 and 10 year rejuvenation, if the plug end is removed and inspected and found to have corrosion or burning, trim the wire by 1/4 inch or 3-4 mm so as to get clean wire at the ends, then re-screw your terminal plug into the coil and plug cap the wires will normally be fine. After 1000 hours or so, change the wires due to corrosion as copper won't hold up after 10-15 years in a moist environment. Look at your plug caps closely also. These do get bent, worn and fail the Rotax pull test. See below.

### **Plug caps and spark plugs:**

#### **Problem: Mag drop rough on B mag.**

**Culprit:** The lower plugs tend to run rougher on the lower module on a 914. (The 912S plugs fire top plugs on cylinders 1/3 and bottom plugs on cylinders 2/4 on one module and opposite on the other side so you don't necessarily notice the difference between upper plug and lower during a 912S mag check.) However, if checking the plugs on the 914 revealed no problem with gap or continuity. The NGK cap ends can be bent, corroded, or installed incorrectly so as the plug contact stem is outside the circular metal contact in the boot. This poor contact can cause rough running.

**Maintenance:** Unscrew the plug cap and check the wire end as well as the cap inside for corrosion and if the clip is bent out of shape. Changing the plug end is the best answer if corrosion is significant. I keep one in my spares bin.

**Service:** Change the plugs annually, they're cheap. I change mine every annual or 100 hours just because you are removing 50% of the plugs for the compression check anyway, just change them all. However, if you clean the plugs, because let's face it, they don't wear in 50 hours, here is a technique. Simple brushing off the residue on the plug will not assure quick starts and low mag drops. Consider cleaning the plug in an ultrasonic cleaner. AV Gas as well as MoGas and the turbo leave a wet buildup on the inside of the plug from the cavity up the side and to the center electrode which dries and leaves a carbon trail. This build up effectively shorts the plug, especially when wet with fuel and oil. This makes starting with a low torque starter very difficult. The ultrasonic cleaner thoroughly cleans out the plug to near new status unlike brushing and carb cleaner, plus it saves time as the cleaner cleans all the plugs in 20 minutes. Try to clean the plugs in a vertical position to allow all the crud to fall out as gravity works 24/7. Never reuse a dropped or damaged plug. If it fails internally, you can't tell. Double check plug caps every time you reinstall your plugs and check for corrosion and bending and a tight fit (there is a cap pull force of 30 N or 6.75 pounds friction force on a plug cap). Because the system is a double spark (fires on every rotation) troubleshooting a

plug or coil with a timing light is very difficult. I look for an obvious miss, but on such a low energy system, a fouled plug won't spark but you may or may not get a timing light flash. It is frustrating. Only if a circuit is completely out, you can see it on the timing light. Another check is you can simply pull the suspect plug cap off and note if the roughness changes. If you still suspect an ignition problem, read on.

## **Grounds:**

**Problem: Engine intermittently rough.**

**Culprit:** Always check the grounds first on any ignition or stumbling problem. There is a service bulletin or instruction on the ring terminal crimps to check for over crimping and wire cutting and cleanliness, so pay attention to them and keep them clean and bright.

**Maintenance:** Every 5 years at a minimum, unscrew the ignition ground wire bolt, inspect, clean the terminals and check the crimps. If all is OK, reinstall. If it still has an intermittent roughness and the coils, wires and plugs are OK, it is most likely the carbs so read below on carb issues.

## **Charging problems:**

**Stator:** Charging seemed weak and the regulator proved OK.

**Culprit:** The main yellow dynamo wires have poor insulation and are not mil spec wire. If running at a full 18 amps continuous, the wires heat, the insulation gets soft and fails. The wires then short. This was fixed with a new stator in 2004-5 and is an expensive repair. If you suspect your dynamo is failing with low charging and the regulator is good, check the wires. It pays to ohm them out as well as test the voltage during engine operation. See Rotax Heavy Maintenance Manual.

**Maintenance:** Remove the GG wires from the regulator and Ohm out the yellow leads per the heavy repair manual. Check the wires for soft insulation or damage to the engine. If no damage is found check resistance. Resistance between the GG wires should be 0.1 to 0.8 ohms and neither of them should be grounded which indicates the coils are OK. Fabricate two wires from the GG to a volt/amp/ohm meter. Set the meter to AC amps and secure the wires to the probes with insulated test clips. Start the engine and set power at idle. The AC voltage will indicate 10-15 AC volts. Increase the RPM to 2500 and the AC voltage will rise 5-10 volts. Shutdown the engine. If the voltages check good, it is not the stator. However, if the wires coming out of the coils are damaged, buy the special tool to remove the rotary magnet and remove the stator. Check the wires completely. If a problem is found say at a clamp, rewire with #10 or equivalent Tufzel coated mil spec wire, or any good quality #10 aircraft grade wire. Hopefully, you can still get a proper lead off the coil to get a solid solder joint fix. I solder the leads at or near the windings, and seal with heat shrink, epoxy the leads at the coil to prevent vibrational fatigue, then run the wires to the regulator. If the wires are in good shape and only the insulation is slightly damaged or soft, recover the existing wires and

insulation with heat shrink. It will last for years but the wire must be in excellent shape and the connection to the coil secure. If in doubt or you discover broken strands replace the wire or safer yet, replace the whole stator coil for \$1000+.

### **Regulator:**

#### **Regulator No Charging:**

**Culprit:** Charging completely quit.

If the volts suddenly fall off or the ammeter shows a discharge the first thing I check is the stator ohms and then start up and check the AC current volts. That pretty much isolates it to the regulator. Much has been written about these Ducati regulators. My Rotax dealer has a regulator checker they use for troubleshooting, and this is what I learned. The Rotax can only charge up to about 15 amps before voltage starts to drop from the 13.8 volts it should charging at. Above 15 amps the voltage begins to sag, and by 18 amps, the regulator is getting stressed (fairly warm), voltage output drops and it will die soon. No amount of cooling air will keep an overworked regulator from dying.

**Maintenance:** Remove and replace your regulator and cut your amp load.

#### **Regulator troubleshooting overvolting:**

**Culprit:** Charging voltage is higher than 13.8 volts or the regulator is failing very often.

**Technique:** The regulator circuit is designed to connect the “B+”, the “C” and the “R” to each other directly. The C, or control voltage, must be the same voltage as the R and B+ or the regulator will try to drive itself to raise the C voltage to the desired 13.8 volts. A low C or Control voltage may kill your regulator at a higher rate. Reference the Rotax Heavy Maintenance Manual.

Many builders will run a power lead from the battery directly to a fused main buss and the C from the main bus through an alternator switch to or from an automatic bus controller back to the regulator C. This is to allow the alternator switch to cut the Control voltage (to zero) and stop the regulator. The short run from the main bus to the regulator through the alternator “field” switch doesn’t seem to cause much of a drop in voltage but in the automatic busses (such as the EXP), because of their design, they supply a lower output voltage from the bus (and consequently the control voltage to the regulator) by some .3 to .5 volts due to the PTCs used. The PTCs they use as automatic circuit breakers absorb a small amount of voltage by design to the output side of the power lead to the component. If the control voltage supplied is lower than the output voltage, the regulator allows more current/voltage from the dynamo to compensate in an attempt to reach its desired 13.8 control voltage, which stresses the regulator. This may cause premature regulator failure. My technique is to follow the Rotax manual more closely, and install a small 30-amp relay rather than a 30-amp mechanical on/off switch, between the R/B/C terminal and the bus to cut dynamo power in the event of an emergency. The cockpit alternator switch is wired to activate a 30 amp relay (as a DC switch) to turn on the relay to allow an alternator to buss connection. Closing the relay allows full battery power

from the R/B/C terminals to the bus which prevents a voltage drop to the C circuit and provides better regulator performance.

*Note: 914 owners should run the aux boost pump off the R/B/C terminal connection prior to the relay. This direct connection from the regulated power directly to the aux boost pump switch breaker is in accordance with the Rotax install manual. The intention of the Rotax installation manual wiring of the Aux Boost Pump is so that in the event of a battery contactor failure or buss failure or even shutting off the master and alternator, the Aux Boost Pump for the 914 will get power as long as the dynamo and regulator are working.*

Regulators get quite warm. Cooling air really helps. Try not to get the Ducatti Regulator hotter than 175F. This is hard to do after landing on a quick fueling stop on a cross country. Some builders add a duct/piping to blow ram air directly on the regulator. That is great for in flight but on a stop over quick turn, the regulator is hot in the engine compartment. Open your cowl flaps or access doors while refueling to vent the heat out of the cowl or the regulator may die on you while taxiing out for takeoff on a hot summer day. A basic wiring diagram is shown below with the Aux Boost Pump wiring highlighted in yellow below:

**Rotax Power Distribution Using Relay for Alternator Control**

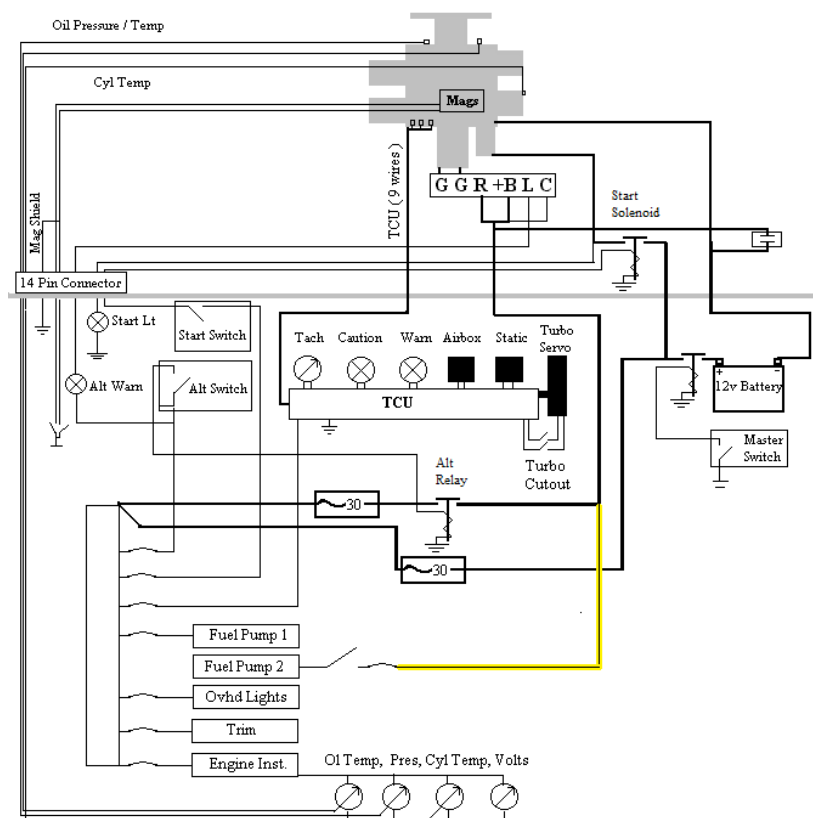

**Add on Aux Alternators:**

**Culprit:** Low aux alternator output from the gearbox PTO driven alternator.



**Cause:** The gearbox PTO only turns at prop speed. This is OK for a vacuum pump but not so good for an alternator. Any alternator will be turning too slow for proper operation. A 40 Amp B&C alternator attached to the PTO will only deliver about 15 amps at cruise (5000 RPM). Nil at idle or approach speeds. Simply look at the RPM vs output graphs on these alternators. At 5000 RPM the gearbox is only turning 2050 RPM. You are getting no more power than the Rotax alternator can deliver at cruise and less at lower RPMs. Gearbox driven alternators are only good as a backup in my opinion or for split bus operations. At idle or during approach these alternators cannot keep up and the battery drain can be significant in an IFR equipped aircraft.



B&C alternator shown.

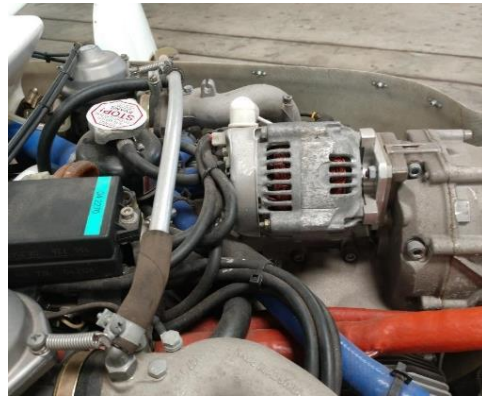

Handmade Denso PTO drive

**Technique:** Install a belt driven alternator. The pulley ratio allows full current delivery at 14+ volts. It can easily put out all your power needs down to idle power. This requires modifying the cowl and perhaps the propeller slip ring pickup of your Airmaster Propeller or similar electric propeller. Another new type of rotor attaches to the back of the Rotax engine shaft and drives another Ducati style alternator which works just fine and does not require cowl modifications. I've never installed or used one.

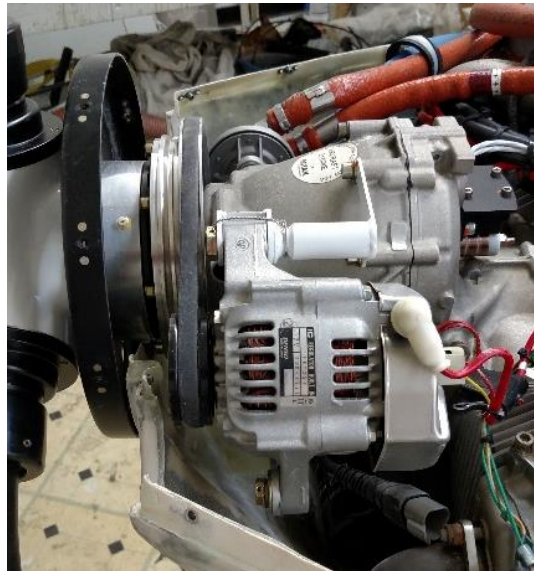

Rotax belt driven alternator.

### ***Auxiliary Alternator noise:***

*Some of these Denso Alternators make a tremendous amount of electromagnetic noise which will cause erratic engine instrument readings, cause RPM and prop interference to the hall effect pickups today's EFIS/EIS systems use. Always use a two-circuit alternator setup, which allows you to turn off the auxiliary alternator and run on the Rotax internal alternator as a backup and for troubleshooting interference or charging issues. If the interference goes away with the belt driven alternator off, the Denso is causing the problem. Install shielded wire, capacitors and in extreme cases, mu metal to control the electromagnetic noise of the alternator.*

### **914 Turbo Problems:**

Full disclosure: My 1999 Rotax 914 Turbo is unique as I stated above. The new 914s have somewhat better supports for the turbo. For the TCU troubleshooting the Rotax maintenance manual is quite good for specific component troubleshooting but poor for symptom diagnosis.

### **Turbo Mechanical:**

**Culprit 1:** Cracks form on the support around the ring on the hot section where the bolts attach. The stainless bracket is brittle from heat cycles. Cracks here will cause bracket failure, the turbo to vibrate, and the tubular arm will fail next. Cost of a new turbo is at about \$8000.

**Maintenance:** Inspect supports every oil change. Once a crack is detected, remove the turbo, from its bracket, and weld stainless washers (507 is OK) to reinforce and prevent cracks around the bolt holes. Newer 914 models (2006 and up) are better supported but bear watching. If the tubular support is cracked, this must be removed and replaced or repaired with a sleeve installed inside the tube and welded in properly. Do not weld around the crack as a quick fix, as it will fail again.

**Culprit 2:** The ring mount to fuselage engine support locking nut (binx nut) loosens on the engine mount near the turbo bracket on the lower starboard side mount. This loose support and resultant vibration of the turbo support will cause the remaining turbo supports to flex and eventually crack or fail. This can cause the exhaust pipes to crack as well. Watch for engine support bolt security and use safety wire, torque seal or appropriate high temp lock bolts/washers to assure security and ease of tightness verification.

**Maintenance:** Loop a safety wire strand through the slit in the binx nut and secure it from loosening. I don't do this for the other three non-heat stressed Binx nuts, which I should. Never use a Nylock type nut as the nylon can't take the heat. (Binx Nuts are all metal, prevailing torque type self-locking nuts with the locking action provided by two slots cut into the side of the nut. The locking action of this locknut works on the diameter and the thread pitch, which counters loosening via heat, stress or vibration.)

### **Oil leaks at the Turbo:**

Oil can come out of the turbo seal and out of the small oil reservoir under the hot section of the bearing.

**Culprit 1:** Oil is coming from the oil reservoir under the turbo only.

**Maintenance:** There is a small ball and spring check valve in this reservoir for the oil return line. If oil is coming out of the turbo reservoir, your ball and seat need cleaning. Simply remove the reservoir and its lines, clean the seat and the ball. Install new seals and reinstall. That takes care of one form of oil seepage out of the turbo.

**Culprit2:** The turbo is the lowest point on the engine, oil will pool as the internal ceramic seal works great when hot, but drips like all get out when cold. The oil can come from the pressure side of the oil pump where there can be no ball check valve to stop this flow of oil. This slow leak through the plump into the turbo and crankcase will cause oil to flow through the turbo bearing, and out around the hot and cold side turbines into the exhaust and turbo inlet. The oil will eventually run down the supply line and fill the turbo until oil runs out of the mouth of the turbo and into the filter and muffler. You can't do a thing about this pressure side oil seepage. To add further to the insult, the oil on the hot side is forced through the exhaust and will coat your aircraft belly, flap brackets or left gear leg if you have a trigear. NASTY! This drippy oil not only causes the filter to get oil soaked, then it slips and falls off the turbo inlet on engine start or in flight. Always safety wire, the filter. To cause more issues, on engine start, the oil pooled in the compressor section is flung into the plenum, coating the carbs, the fuel pressure regulator inlet, and sensors as well as your plugs, causing poor starting and rough running. The burping process of the 914 is very frustrating as the crankcase pressure is lower than the 912S and oil is pumped through the turbo and its seals, and will not vent out easily of the crankcase and back up into the oil tank without many revolutions. This burping action pumps more oil through the turbo and out also. Eventually the oil-soaked plenum rubber hose connecting the inlet to the carbs and the plenum won't stay on under boost and the plenum inlet will simply slip off the carb and reduce your 914 to a 912 (80 HP) due to boost pressure loss. Many safety wire the plenum on. I have a different technique later in this section.

**Culprit 3: The smoking engine:** If the engine smokes like it has a smoke system added to the aircraft, your turbo ceramic seal has failed, and oil is coming directly from the oil pump through the oil seal and then into the intake and exhaust. This causes a lot of smoke and will deplete your oil reservoir in short order depending on how bad the seal is worn. Land as soon as possible and investigate if you see smoke.

If you plan not to run your 914 for quite some time (over a month) drain and put Avgas in your tank and run it through the carbs. Fuel stabilizer in AV Gas works well. Rotax recommends you recondition the engine and do a full 100-hour inspection. I just take a day (yes, plan a whole day) and prep the engine (and airframe) just as I would in an annual inspection. I recommend you properly preserve and then recondition the engine if stored over winter for six months IAW the Rotax Line MX Manual. If you just haven't flown for a month or two, I developed the checklist below which seems to cover all the problems common on waking up an engine that has sat for a time. You 912/912S owners have it made. Simply prop your engine over, hear it burp, check fluids, drain out the old fuel (hopefully you used fuel stabilizer) from the system, refuel with AV Gas, run your engine and check carb balance, leaks and systems and you are very well on your way for the flying season. For me and my 914 I do this:

## **Reconditioning a 914 after a long layoff (over a month or two):**

### **912/914 Reconditioning:**

1. Charge the battery fully. Drain your fuel system unless using AV Gas and stabilizer. Fill the tank with fresh fuel and check the filters.
2. Hand turn the engine until the oil tank gurgles or about 30 revolutions to bring the oil level in the can to at least the half to one-quart low point on the dipstick. (This also ensures the hydraulic lifters are full of oil.) I pull the air filter and using a very long needle, suck the excess oil out of the cold section of the turbo. I also ensure the turbine rotates easily and has not frozen and the waste gate moves freely. Reinstall the air filter.
3. Start the engine if possible. Use a battery boost function on your charger if necessary, to spin the engine to at least 275-300 RPM to get a good spark and it should start.
4. Check the oil pressure immediately and run the engine until the oil tank is warm.

### **If the engine will not start (not uncommon for the 914 and sometimes the 912):**

Pull the plug wires (leave the plugs in) and using the starter, turn the engine over while monitoring the oil level in the tank to get it to gurgle and check the level. Do not exceed 10 seconds of cranking for each one-minute cycle. By now it should gurgle for sure. Again, RPM on the tach should be at least 250 RPM to get spark (300 is better), if not, check your starter as it may need a rebuild. Oil will pool up in the turbo inlet and exhaust and be blown into the engine and out the tail pipe. Suck out the oil again from the turbo and reinstall the air filter. Pull the plugs and ensure they are clean and dry or just put in new or cleaned plugs. Attempt to restart the engine.

### **After the engine starts.**

5. Check oil pressure and temps are up. Shut down the engine after it is good and warm.
6. On the 914, pull the air filter again and suck the oil out of the turbo inlet if present. (It should be dry.)
7. On the 914, loosen the intake plenum and then pull it back just enough (with the plenum no farther than an inch back from the carbs so as not to bend/damage the fuel lines) to check the carb is clean of excess oil. If oil soaked, use carb cleaner to flush out the excess oil. If the carbs have paper float bowl gaskets, the gaskets are probably dry, and your carbs will leak air and fuel. Pull the carbs and check your neoprene or rubber gaskets have not shrunk or install new neoprene/viton rubber gaskets or paper gaskets and torque down.
8. If the 914 turbo inlet is still oil wet, use carb cleaner/acetone to clean the air filter lip, and flush out the plenum of oil and wipe the rubber plenum attachment tubes of any oil. Safety wire the air filter back on.
9. Disconnect the pneumatic lines to the 914 carbs for fuel leakage and inspect all of them. Check for cracks and that they are clear of oil. There should be no fuel in the carb vent lines. If there is, pull the carbs and check the floats IAW with Heavy MX Manual that they are not sinking in the bowls as your carbs may be flooding.
10. Using carb cleaner clean out each of the 914 plenum pneumatic ports, especially the hi pressure turbo port.
11. Using a 12-volt wire and ground, check the solenoid for operation as it will fill with oil and may stick or not be clear and restrict airflow. Using light air pressure clear the solenoid and valve of oil.
12. Reassemble the plenum, solenoid, lines, plugs, and carbs.
13. Start the engine again. Allow to warm up.
14. Check your temps and pressures and hopefully the oil droplets stop coming out of the exhaust and puddling.
15. Once the oil temperature is above 100F, run up the engine to 4000, check the mags and then run up to max continuous power 5500 RPM /34 or 35 inches MP. Check operation and smoothness. Let it run for 5-10 seconds to burn all oil off the plugs then attempt a full throttle run and check 5700 RPM/ 38-40 inches MP and smoothness. Watch your cylinder head temps as your cowl is off and your radiators are not cooling efficiently.
16. Retard the throttle to idle, check idle smoothness by looking at the ignition module vibration. If the modules are nice and steady, idle for a minute to cool the turbo, note your idle RPM, oil pressure and check your carbs for leaks and shut down. If idle is not smooth, do the below.
17. When the engine has cooled, pull the plugs and replace with new or cleaned plugs if they were badly oil soaked.
18. Check your carbs and fuel lines carefully one more time for fuel leakage and fix any leakage on the float bowls and safety wire the 914 bowls if you had gasket or float issues (use new neoprene fuel gaskets and if in doubt, change your floats). Restart after maintenance and perform a carb balance if idle was rough.
19. Reassemble and restart the engine and recheck performance from idle to full power. It should be fine.
20. On your 914, clean your air filter attachment lip again as well as the plenum rubber tubing clamping areas if still showing an oily film, just to ensure a tight oil free clamping area so they will not slip off during the flying season. Then safety wire the filter as necessary. Cowl up the aircraft, hook up the battery tender and call it a day.

Note: I perform a 25-hour inspection of the airframe checking for brake, fuel, and tire leaks while the engine cools during the runs. Check the pitot and static, avionics and instruments, tires and brakes and you should be ready to fly. Start the engine the next day and check out engine operation again. Check the stabs, ailerons and flaps work as prescribed in the manual. Wash the airplane, fly it dry and oil the hinges,. If all is well, congrats, you are ready for the flying season. If not continue to fix it right.

**Turbo Maintenance Annual Checks:** Run your 914 engine and fly often to prevent oil pooling issues, lubrication of engine internals, cycle out the old fuel out of the carbs, and any moisture in the oil. Clean your 914 plenum inlet out annually or by 100 hours with carb cleaner sprayed into the carb side of the plenum (don't get carb cleaner on your windscreen) and let it drain out. Suck the pooled oil out of the turbo if it has sat a long time (six months to a year storage will fill the turbo and filter) to prevent pooled and congealed oil from throwing the turbo out of balance and fling it into the intake. Clean or change your plenum to carb inlet hoses for good traction for the clamps. Once these hoses become oil soaked, they are worthless, clean them or change them. If on cross country and the plenum vibrates off, safety wire the plenum to the carb to get home, then clean or change your carb to plenum hoses for sure.

*Note: Always safety wire the air filter on to the turbo to prevent loss of the filter. I have small springs that attach to a safety wire loop on the filter and the other side of the spring is safety wired around the turbo.*

Once all this work around with safety wire and cleaning is done, start the engine and warm it up. Run to full power, and fly with reckless abandon, land, and wash off the oil on the belly. You will be good for another year. (GOD, I HATE IT, BUT LOVE IT!)

**Waste gate sticky:** Oil, heat, corrosion etc. causes the waste gate to stick. Use penetrating oil and make sure the waste gate operates freely every oil change. Adjust the cable properly. The waste gate should be full closed or allowing full turbo at idle and engine off, but it must not be hard at the stop in my opinion. During initial electrical power up, the servo will pull the cable slightly farther open (there is a spring in the servo sheath to allow the extra pull ) then it will continue to cycle full open to closed and stop just shy of full tight. The cable sheath should be just touching the return spring snugly and should keep the cable taught with the waste gate at idle.

**Maintenance:** If the waste gate squeaks or seems sticky, lube the waste gate shaft with penetrating oil, high temp mouse milk or similar and cycle the waste gate by hand until smooth. Operate the servo to check the cable performance.

*Note on servo installations: To prevent the loose end of the servo cable from fraying and flapping about, fabricate a tube for a guide for the cable coming out of the servo to keep the end of the wire from binding or fraying against bulkheads. The cable end supplied is long, and whips around during its cycling, and may jam against the bulkhead and can loosen over time and get frayed out. I make a tube to keep the cable in a sleeve and this keeps the operation silent and guides the cable to prevent a failure right at the set screw. Many installers follow the Rotax manual and put the turbo servo behind the firewall, and any problems with the servo installed in that position are a miserable fix. Consider making a box and mounting it to the firewall or foot well top with a supply of cooling air, where it can be maintained easily.*



*If a box or bulkhead was fit tightly over the servo, the cable would flap around and start to fray. Put a piece of brake tubing over this exposed end as it fits very snug into the servo hole and the cable stays perfect for years.*

*Note: To get the turbo waste gate to a position where you can manually rotate the arm, you must be quick. Turn on the master and turn it off quickly (or hold the reset switch) then turn off the master. Hopefully it stops the servo at the fully open position (cable slack, or servo 180 degrees counterclockwise from idle position).*

## **Carbs:**

**Leaks.** Any leaks in the float bowls, carb exterior, or internally (as in fuel is burbling out of the carb inlet), must be fixed immediately. The fire hazard and float chamber air leakage and poor running are not worth it.

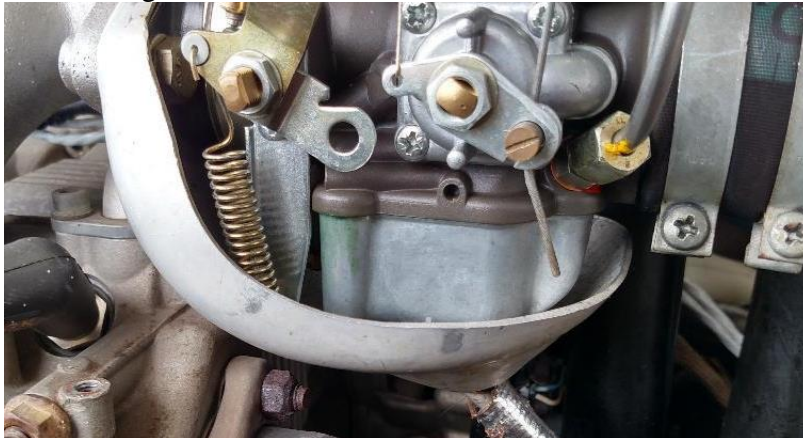

*This carb has a faint blue stain from on the front. And the bowl to carb body shows it has a blue/green/brown stain line from the AV Gas. This carb must be removed, and a fresh gasket installed.*

**Engine roughness, vibration or shakes:**

If vibrations or roughness is felt at idle, I normally start with the carbs, then ignition tests, then I go to mechanical engine problems.

***Warning: Excessive carb shaking will damage the slide pistons, body and needle jets forcing you to purchase new carburetors. They are expensive. Keep your carbs balanced.***

*Notes: 90 percent of the rough running issues are the carbs. Balance of the carbs must be done at idle for smooth ground operation but for optimum engine component life, must also be smooth from idle to full takeoff power. Any out of balance in the mid-range will cause excessive shaking of the engine. Most of us can tell when we have a small vibration in our engines and investigate immediately as small things never get better. We have had folks completely change out an engine, because they couldn't get it to run smoothly and were fed up. The old 912S engines were a bit shaky and you could feel vibrations in your calves even at cruise. No amount of carb synchronization, ignition swap out, tuning and prop balancing can fix a bad engine. The Rotax should run without the ignition modules shaking vigorously due to roughness from idle to takeoff power. I have heard it said many times and found it to be true that in the mid-range from 2000-3500 RPM (before the main jet takes over and the pistons are fully up) there will be a slight vibration over a small RPM range due to the carb pistons being slightly uneven causing an out of sync condition. Avoid this rough engine operating range if possible. This piston sync issue can be checked with a mirror while running and you may be able to correct this problem with a carb rebuild. Normally, the engine should be smooth from idle to full power. About 2500 RPM the prop should be pulling hard enough that the gearbox will not clatter, and all should be smooth and quiet. Do not confuse gearbox clatter caused by a tail or cross wind changing the prop load with a rough engine while tuning carbs. Point into the wind when tuning and balancing. If you can read the lettering on the ignition modules easily, the engine is pretty smooth. I can go two years with only a check of the ignition modules shaking as if they are tuned correctly.*

*Note also: If the prop is out of balance statically, or dynamically, or not tracking properly, it can cause you to think it is the engine. If your engine shakes to the point where the ignition modules (and your body) vibrate, and the engine has been checked, have the prop looked at. Most prop manufacturers (Warp Drive/Whirlwind/Sensenich) statically balance their props. Airmaster balances their entire prop hub and blades, so these props when new should be very smooth. Always do a static and dynamic prop balance so the prop/spinner/gearbox and engine will be balanced together. Most of the time, vibrations of the engine/gearbox only need a few grams of weight on the prop spinner backplate to balance out the engine/prop combination and make the engine/prop combination smooth. Make sure the spinner runs true as it can cause significant vibration. A good dynamic balancing of the prop after a carb tune can sometimes allow an owner to isolate whether his vibration concerns are a mechanical engine problem or not. The newer graphical dynamic balancers will show intermittent roughness very well. Invest in a proper prop balance.*

**Symptom:** Engine starts OK. Idle to 2000 RPM the engine really shakes even with the crossover tube attached. The carb mechanical balance is off.

This is a basic carb setup problem. Make sure the throttle cables are working smoothly and the engine is at operating temperature. If the carbs cannot be set on the same manifold pressure, the throttle plates or idle circuit is not set up properly. Pull the carbs and rebuild them.

**Maintenance:** Most Rotax mechanics will rebuild the carbs every two years or a couple hundred hours. I highly recommend this. If they are running smooth it is a bit overkill to remove your carbs just to renew the O-rings and gaskets, but the throttle O-ring does wear and will leak and mess up the carb balance. The only way to pull the throttle O-ring is to remove the butterfly valve. So, you may as well do the whole carb rebuild. If the carbs are dirty or not running perfect, rebuild the O-rings and gaskets at a minimum but it only takes a few more minutes to do a complete rebuild. The diaphragm and manifold to carb rings generally last 5-10 years. Look for cracks and wear on every annual or 100-hour inspection. **LEARN HOW TO REBUILD THE CARBS!** There are excellent Rotax videos on this. A common item missed when building the carbs is mechanically setting the carb throttle plate. Install the throttle shaft and plate but keep the screws loose so when closed fully, the butterfly will adjust and fit sufficiently tight that little or no light penetrates the bore wall to butterfly plate gap. Then set the throttle plate screws and peen them to the shaft. A poorly aligned throttle plate will not allow a proper carb balance and throttle arm will stick at idle. I must confess I use Loctite 243 on my throttle plate screws and just squeeze the end threads on the butterfly set screws with a needle nose plier rather than banging on the screw and shaft to peen them. With a little heat the screws come out without damage to the throttle shaft on rebuild. Once a good throttle butterfly seal is assured, to set your mechanical balance open the bore with the idle screw to expose the second small hole located in the bottom center of the carb exit (it is a .020" super small hole behind the air bleed enrichening hole), or just follow the Rotax mechanical set procedure.

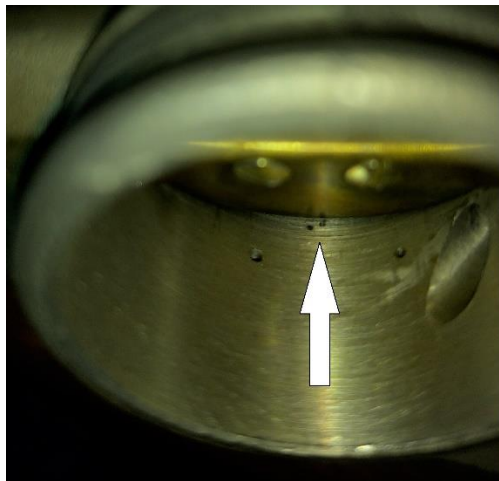

(Make sure your idle stops are not bent or damaged. These stops must be even.) The carb initial setup above will allow an engine start and will be extremely close to balance. They will be easily capable of setting dead equal using a manifold pressure carb balance kit. With experience one can tune by looking at the engine and tune by ear and eye until dead smooth at idle and then confirm with the pneumatic tuning kit. Any carb adjustment should only take the moving of a single cable fore or aft a half turn or so of the cable sleeve nut to achieve an even idle. Remember, the engine idles rough with the crossover tube disconnected and the carb balancer installed. Just check your



pneumatic balance is even with the carb tune kit. I set the idle to 1650-1700 or so when using an Airmaster with the idle stop on the carb. I then adjust the throttle stop screw in the cockpit to get an idle of 1750-1800. That way if I keep overshooting the airport, I can back off my idle in the cockpit a bit for summer landings or compensate for winter low inflight idle by turning a screw in the cockpit. *See Airframe throttle cable maintenance.*

**Symptom 2:** The engine becomes rough or has excessive RPM drop during ignition/mag check, but very smooth running at 4500 to full power. This is a typical carb sync issue.

*Note: I use only a match set of gauges to tune my carbs so I can see exactly what the manifold pressure is behind each carb. (Check your pneumatic balancer for accuracy before use by installing a tee between them and a mechanics hand vacuum pump (mine is a Mityvac vacuum pump.) Never balance the carbs at idle only and go fly. Always run up through 5000 RPM to check the manifold pressure difference between the two sides. I do not use the electric balancers sold by Rotax as they are not as easy to see the pneumatic pressure difference when I run the throttle up and down. Gauges are easy to read. Once I set the balance, and have adjusted the cable set nuts, it is not uncommon that after the engine cools and a restart is done a day later, the setting may be off just a bit as the cables and carbs are cold. Let it warm up and adjust again if necessary.*

*If you change fuel from auto fuel to AV gas the engine will idle slightly faster. If your auto fuel is old, it is difficult to get a good idle or tune sometimes. Use good fresh fuel.*

**Culprit:** The manifold pressures during the carb balance check are way off during run-up above 4000 RPM. (Pistons in the carbs do not operate in unison.)

**Maintenance:** Rebuild the carbs. Rotax will tell you to buy new carbs and have Rotax tune them to match. Or you can troubleshoot as I do below:

### **To check the carb pistons operate in unison:**

With the carbs dry and free of fuel, I hook a Y pipe to my shop vacuum cleaner (complete with used carb manifold gaskets) to pull air through both the carbs simultaneously as the engine does. I operate the throttles in unison to assure the carb pistons also operate in unison. If they don't move together, start looking for why. On top check the rubber diaphragm is seated properly and leak free. Any leak in these expensive rubber diaphragms will cause serious imbalance in running above 2500 RPM. Since the diaphragm takes its vacuum pressure from the carb piston holes near the throttle plate and pressure on the top side from the inlet, the spring and pressure balancing act is very delicate. In the rebuild of the carb, you must check that the piston and the body have no burrs or wear issues. If the body is badly scarred, or clearly there are rub marks, your piston has cut a slot in the body wall and is probably hanging up or loosing suction. This is caused by a foreign object or your engine has been shaking so long it has caused the pistons to slap the body side until worn out of round. In this case, it's time to buy a new set of carbs. If the pistons do move together, check the floats and Viton tipped float needle valve.



Vacuum cleaner setup to check carb pistons.

**Symptom 3:** The engine is rough from mid-range to full power.

**Maintenance:** If the manometers are even, it's electrical, or mechanical. If the compression is good, it's most likely electrical. Check the plugs again. They may be oil/gas soaked or carboned up. If a burble is found at mag check on one mag, you may have a bad set of floats or Viton needle valve problem.

If the floats and float valve are good with no leaks, install the carb on the plane and start it up. Do an initial balance. Run up the engine. I normally see no more than 1/2-inch Hg difference in manometer pressures from idle to full power. If you see large differences in pressures during run up, you have a piston sync problem. If you are in the field and don't have a vacuum cleaner to check as I do above, and suspect the carb pistons are out of sync, then pull back the plenum from the carb a bit and use a mirror and check the pistons for operation. *USE CAUTION as you are close to the prop. Tie the plane down well.* If one piston is higher than the other, take them off again and investigate. Expect to be wind blasted so keep FOD (Foreign Objects) from going in the carbs while doing this. It is much nicer to build a test setup as below and bench check the carbs.

### **Manifold Leaks:**

Leaks in the two manifolds going from the carbs to the heads, and the tubing connecting the carbs to the intake plenum, are easy to troubleshoot. Use a bit of oil around the manifold fittings to determine if both are tight. If the carbs look good and are tight, and you suspect the manifold, the manifold is sealed with an O ring so remove the manifold bolts if the carbs are way off, inspect the O rings. It is common to lift the engine by the intake manifolds. Occasionally this will crack the manifold at one of the ears. The mating surfaces should be very clean and flat, if not, talk to a professional. If the manifold pressures are way off, check the compressions are within a couple pounds between cylinders during the compression check. If off by 10 pounds, fix the mechanical problem first.

### **Carb air leakage:**

Knowing where to look and paying attention to what the solution is to a carb bowl air leak or manifold leak and recognizing its symptoms is not intuitive. The first thing to note is that the float bowl must be at the same pressure as the carb inlet (plenum exit to

the carb), or mixture control will be affected. The small tubes that attach to the carb bowl to the manifold must be clear and sealed well. Never assume on a 914 that the rubber hoses or the float bowl rubber/paper gaskets, or manifold attachments are good. Check them carefully for cracks, shrinkage, hardness and pinholes.

### **912/912S Carb Pneumatic Leaks:**

The 912 and 912S have only one tube each from the bowl to the intake plenum or filter area. In the 912 Classic, the tube was just tucked under the float bowl clip. Of course, if the tube was bent or crimped shut, the carb float bowl would not vent properly. This manifested itself as a roughness at higher RPMs and during climb out. Also, if the cowl has good draw the carb bowl vent tube is now in a low-pressure area and the carbs lean out as speed increases. Always install the float bowl vent tubes into the intake plenum as shown in the Europa XS Rotax installation manual.

### **914 Plenum:**

This is a bit trickier. The 914 Bing carb vent or pneumatic plumbing is more complex and requires close inspection. The 914 Bing 64s are designed with a pressurized float bowl. It is essential that for proper atomization of the main jet when boosted above atmospheric pressure the bowl must be near to the pressure of the air box plenum and fuel pressure must be above plenum pressure by roughly 3-5PSI or fuel will not atomize and flow into the carburetor and the mixture will be affected. If the airbox pressure exceeds the float bowl static pressure, the plenum pressure will reduce the atomization or suction that draws the fuel from the main jet and needle below the piston (the venturi area) and lean out the mixture significantly. This ratio of fuel pressure to airbox pressure AND the ratio of airbox pressure to float bowl air pressure is essential for full power operation.

To prevent excessive plenum to airbox differential fuel pressure at the turbos max pressure of 5 psi, the turbo control unit uses two plenum taps from the plenum tube to the carb float bowls via an air solenoid to prevent leaning of the carbs and proper plenum to float bowl pressure ratio under full boost conditions. One of these taps is at the top of the vertical tube coming from the turbo (ram pressure source) and the other is near the fuel pressure regulator in the center of the airbox which is an average air box air pressure. When running at max continuous power (35 inches MP) or less the airbox air pressure is directed to the carb float bowls and pressure regulator directly from the center pressure port of the plenum. The fuel pump of course only puts out nominally 5 PSI regulated pressure at low power settings and as power is increased the air box pressure builds to about 2 PSI at max continuous, so the effective fuel pressure of the fuel pushing into the float bowl is only at 3 PSI so the pressure regulator must keep the balance. When max continuous power is applied, the fuel pressure is raised to about 7 PSI. At full boost or 115%, now 5 PSI air pressure is in the plenum and on top of the fuel in the float bowls, so the fuel pressure regulator must kick up the fuel pressure to 10-13 PSI just to prevent the fuel from being forced out of the float bowl by the boost air pressure. It does this via the solenoid control and the ram pressure tap on the plenum to increase the pressure a bit more to maintain fuel balance and pressure. If this fuel pressure difference is not maintained the engine will lean out, surge and or run snarly. To assure proper float bowl fuel levels, the float bowl pressure must be kept at least 3-5 PSI above the airbox pressure, a fuel pressure regulator uses airbox air pressure from the center tap to increase the fuel pressure regulator to airbox pressure ratio as required . Therefore, one should see

the actual fuel pressure be increased from a nominal 5 psi plus the boost pressure (about 5 PSI) as turbo power is increased to full boost giving a min of about 10 PSI.

### **Typical 914 manifold/airbox/carb pressure problems:**

#### **Symptom 1:**

If the engine runs fine up to about 30-32 inches of MP, then when full boost is applied the engine begins running rough as if out of sync or one or both carbs is starving for fuel. The engine sounds fine then cuts out then runs up again and repeats itself, is a typical symptom of an airbox line failure, float bowl leak, or fuel pressure regulator failure.

**Maintenance:** One normally assumes a fuel problem, but if one of the rubber pneumatic lines is leaking the pressure regulator is not getting air pressure to increase the fuel pressure to the carbs or one carb bowl is now unpressured and one or both carbs is/are leaning out. This starts out seeming like a balance problem, then it becomes a fuel delivery problem. Check the lines well, as the smallest cut, crack or hole will cause problems. Ensure the lines are not kinked or plugged with oil or debris. If the fuel pressure regulator seems to not want to boost the fuel pressure with airbox pressure, use a vise grip or pliers to squeeze the return line and increase the fuel pressure. If the engine runs better, it is definitely the fuel pressure regulator. In the shop I use a low pressure regulated air source to test my pressure regulators.

#### **Symptom 2:**

The engine runs up to 35 inches or maximum continuous 100% OK, but as soon as full turbo (115%) is selected the engine begins running rough as above. Here, there is either a leak in the tubes going to the carbs, a carb bowl is leaking air, the solenoid has failed, or it is plugged with old oil. Oil is always in the intake plenum and can thicken and plug the ram port on the intake or clog the solenoid. Clean out the plenum every year at a minimum... I begin troubleshooting by shooting a blast of carb cleaner through both the ram pressure barb connection. I also check this fitting is not loose and that it is aligned properly. There is a mark on the brass fitting indicating the alignment of the hole. This alignment must be directly into the air flowing from the turbo. Clean the middle or average pressure tap tube barb connection by the pressure regulator also. Then check the solenoid.

**Solenoid Maintenance:** Before replacing the air pressure solenoid, test it. Hook 12 volts to the solenoid power and ground terminal and you will hear it click. Disconnect and check the air tubes which allow air to be switched from the plenum to the ram pressure tap by using mouth pressure (about 2 psi). It should block air from the tap until the solenoid is energized. Once energized, the air should flow from the high pressure tap line to the carbs. Listen for gurgling from the lines as they may be full of old oil. Clean out with denatured alcohol. If in the field and you can't be sure the solenoid is operating, just re-plumb the ram tube to the carbs by swapping input lines to bypass the solenoid and direct full air from the ram tube directly to carbs and run up the engine to full power (past 35 inches where it hesitated). If the engine runs smooth, you found the problem, is the solenoid. Don't ground run a long time with this setup, as below 34 inches the carbs are getting too much bowl pressure and will run poorly at lower power settings.

*Note on the TCU electrical connections:*

*The TCU plugs do corrode. So not only check the engine mechanical tubing and solenoid, also clean the contacts with a bit of super fine sandpaper and use dielectric grease to increase the reliability of your connections.*

If out on a cross country, the engine will provide max continuous 34-35 inches MP without a problem if the solenoid fails. Just don't go past 100% throttle as described in the Rotax 914 installation manual to get home. It is perfectly safe. Hopefully you built a stop in your throttle at the 100% position to prevent that engine roughness and cut out over 100%.

### **Carb Fuel Leaks:**

Carb leaks as seen by a faint staining on the float bowl, fuel in the tray, and or the carb appears wet (and cool after a run). This is almost always the gasket. The spring clip or bolt keeps good pressure on the gasket, so check for carb flooding or if the floats are sinking). Sinking floats is covered in a SB. If the floats are sinking, the bowl fuel level is too high, it will seep out of the carb inlet, vent tube and cause the engine to be rich on one side, making for a distinct burbling sound on the mag check and may drip out of a dried up float bowl gasket as well. A poor needle seat (that rubber tipped shutoff the floats push on) will also cause flooding and leaking. Follow the Rotax Heavy Maintenance manual procedures for assuring the needle valve and floats are properly maintained.

*Note: Auto fuel tends to leave a varnish when evaporating. This will cause the spring in the needle piston to seize. Although brass and stainless steel with a Viton tip, auto fuel tends to be very hard on these components.*

*Warning: 912/914 float bowl leaks are dangerous. It not only stains the bowl side; it causes fires as it drips raw gasoline on the exhaust stacks directly below the carbs of the 912 (which does not have trays) or sprays out an atomized stream of fuel of a 914 under high pressure. Keep the fuel and fire inside the engine. See below.*

### **914:**

Note: A carb float bowl air leak at full power causes the carb to lean out and EGTs may be high or engine running is a bit rough at low power and at full power will cut out. Of course, a fuel leak should be caught by the drip tray supplied on the engine so as not to cause a fire. But don't trust it. Fix the leak as the fuel float bowl is pressurized so the fuel may be spraying out of the carb to bowl gasket in a fine mist if the fuel level is sufficiently high in the bowl. This is an extreme fire hazard.

*If the engine cuts out at full power it is difficult to see the fuel leak with the cowl off. Technique, if the offending carb feels cool on the float bowl, it more than likely is cooled by the fuel atomization of the leak. Do not attempt to fly. Fix the carb bowl leak.*

**Culprit:** The paper gasket at top of float bowl is dried out, damaged or was not soaked and softened on install or was not seated properly. Plenum pressure leaks out the seal.

**Maintenance:** Paper gasket should be soaked for 30 minutes in fuel to soften so it can compress and take form on installation. Cork or rubber type gaskets are now available. I

strongly recommend these rubberized gaskets. If the float bowl is bent or distorted it must be repaired or replaced as it won't seat the gasket properly. Set the bowl on a dead flat surface and check the upper surface and lower. These surfaces should be dead flat. The two brass posts should not protrude above the upper bowl surface. If they do, the bottom of the bowl is bent up, so read on.

*Warning: Rubber/neoprene gaskets are advertised as you will never have to replace them. That is not true. They shrink with time and will fail to fit the bowl gasket seat. Newer gaskets are made from Viton which should be better, but even if the gasket is not leaking, change gaskets as they crush with time and do not reuse well.*

**Maintenance 914:** Until about 2006, the carb float bowl attachment had a fiber washer. It was replaced with an O ring on the carb nut bottom to allow a better seal as discussed below. If you have an older 914 your torque settings for the float bowl bolt is always suspect, and the fiber washer/bowl bolt if over torqued will bend the float bowl bottom causing float bowl deformation. A bent bottom and over torqued bowl bolt brings the main jet at or very near to the bottom of the bowl and may limit fuel supply at full throttle causing hi rpm leaning or rough running.

Rotax came up with a new idea to improve the seal of the float bowl and prevent bowl deformation and the main jet by adding an O-ring and a new bolt with a recessed O ring seat. It works well. On the older float bowls the O ring can be used but on initial install the O-ring compresses but still allows the bolt to make metal to metal contact. I have found it loses its torque later on. This loosening is due to the compression of the float bowl gasket over time. If torqued again to squash the float bowl gasket the compression nut won't seal well to a slightly bent float bowl. I have found on the older carbs that if I leave the fiber washer on, and add the O ring and new bowl nut, I can torque or squish the O ring to the new specification of 48 in/lb. and wait 24 hours and retighten, I can get buy for a year without re-torqueing or leaking carb bowls with this combination and new neoprene bowl gaskets. The Viton gaskets are better.

I have also managed to get a thicker phenolic ring gasket in place of the O ring. This works so far as the thicker washer prevents bottom of the bowl clearance issues but bending of the bottom of the bowl can still be an issue, so I use the O ring as well. It works OK.

*Warning: Do not overtighten your float bowl. The original Rotax manual had a misprint indicating the float bowl bolt was torqued to 19-foot pounds. The soft aluminum float bowls were bent often. Refer to the new manual for the proper torque of 5.5 NM or 48-inch lbs. Watch the bowl as you torque that it stays square and doesn't distort should the bowl edge catch on the recess in the carb body.*

#### **How to tell if your float bowl is bent:**

When the float bowl is over tightened the bottom of the bowl deflects and the float pins are bent outboard on inspection. The bowl bottom is now concave, and the pickup may bottom out in the circular recess and the carb is not getting its full fuel delivery.



*Note goal post or float posts are bent outboard and note the corrosion caused by six months of ethanol gas setting over a wet winter in the float bowl.*

**Maintenance to straighten a bent float bowl:** Carefully set the float bowl on a flat hard surface and install a large socket which just covers the bottom ring and insert an extension in the upside-down socket. Gently tap the inside to flatten the bottom. Very carefully bend the posts back straight. *Caution, the cast aluminum may crack!* When in doubt, replace the float bowl with a new one. It is money well spent.

**How to remove the carb easily without disturbing settings for gasket maintenance.**  
**914 carb removal Technique:** *Pulling the older carbs off the old style round tight fitting fuel trays is a bit tricky. Normally one disconnects the 12mm compression nut at the carb, bends the fuel line back, then removes the carb from the manifold by twisting and elevating the rear of the carb and pull it out. If the carbs are in trouble and the carbs must be repeatedly removed, the 12 mm compression nut fittings at the carb may be compromised or if through bending the fuel line the compression fitting may become compromised and no longer seal. These fuel lines are difficult to find if one starts leaking. Don't use sealant to cure this problem. Get a new tubing assembly made up or buy one from Rotax. To attempt to repair this compression type fitting, try filing off the tube below the compression bezel end. This shortening of the tube projecting out of the compression nut will allow the V shaped compression fitting to pull down further on the tube and the nut will allow the compression fitting to reseal.*

**Technique to easily remove the carb and not disturb the throttle settings or compression nuts:** *If it is necessary to pull the carb to change the gasket, or measure the float weight or any other maintenance, try this. Disconnect the banjo bolt from the fuel pressure regulator, loosen the manifold clamp and spring and simply rotate and twist the carb with the supply tube and throttle cables attached out of the drip tray. Leave the choke and throttle cables all attached, then fool with the bowls. Pay attention not to bend the fuel line or cables. Reassemble and reinstall the lines and you should not affect the carb settings.*

**Important Tip:** *If you have difficulty flying often enough to prevent your float bowl gaskets from drying out or shrinking. Consider using a 912 style float bowl clip to keep tension on the bowl. This will work very well keeping the upper gasket sealed. Once the bail clip is on, torque the bottom bowl nut to the proper torque of 48 inch pounds. Note on the newer bolt with O ring, this just brings the bolt flange in contact with the bowl bottom and compresses the O ring.*

*The old round 914 drip trays are a pain to work around. The new 914 plenum is quite easy to remove. Some have cut the old 914 drip trays to make them two pieces. It is not worth my time but some of the work I've seen is beautiful. Quicker to simply undo the one fuel line at the fuel pressure regulator and pull the carb off complete with throttle cables attached.*

### **912 Float bowl leaks:**

**Maintenance:** This is almost always the gasket. The spring clip keeps good pressure on the gasket, so check for carb flooding or if the floats are sinking. Sinking floats is covered in a SB. If the floats are sinking, the bowl fuel level is too high, it will seep out of the carb, vent line and cause the engine to be rich on one side, making for a distinct burbling sound on the mag check and may drip out of a dried-up float bowl gasket as well. A poor float needle seat will also cause flooding and leaking. Check the spring on the bottom as well as the rubber for proper operation. On the 912 series watch your clear float bowl vents for fuel. It may be a sign of high pressure or leakage.

### **For safety sake:**

*912 and 912S owners should fabricate a drip pan to prevent a flooding carb float bowl from dripping fuel on the exhaust. One technique is to bend a piece of 0.032-inch aluminum, into a tray shape and simply attach it to the foot well to fit under the float bowl and stop near the cylinder head. Weld the corners or do some fancy hammer work and provide for a line to carry the fuel away from the area as in the 914. Another method is to form an L shaped tray as in the newer 914 drip trays and attach it to the manifold. Or simply buy the expensive new 914 drip tray with the two bolts to remove the tray for float bowl inspection.*

*I prefer to make the tray easy to install and work around. If you cannot weld aluminum, simply hammer a dent in the bottom of the tray and install a small brass threaded hollow nipple to allow fuel to drain clear of any exhaust. These trays also prevent an exhaust leak from impinging the float bowl and boiling the fuel out of the carb causing engine roughness or even failure. See photo below:*



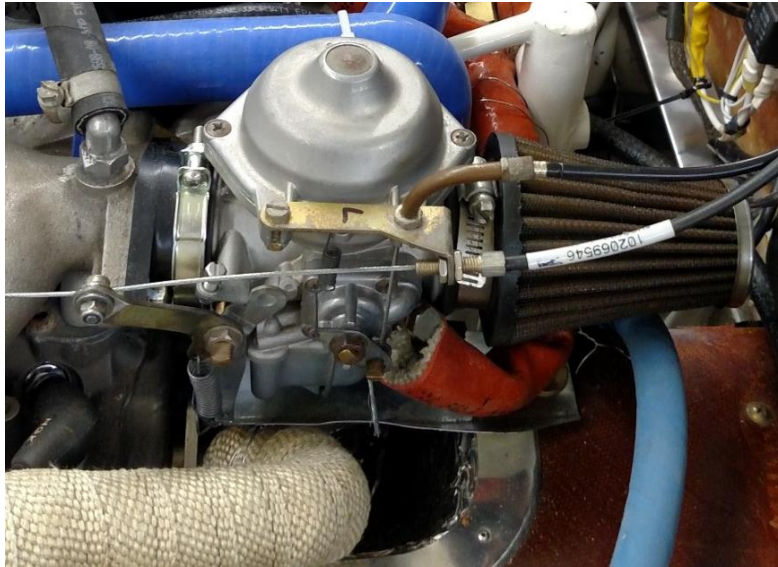

*Shown above is a Classic Europa with a simple hammered tray catching any fuel leakage and draining the fuel inboard clear of high heat areas. It is also an excellent heat deflector if the exhaust pipe leaks at the head.*

### **Internal Carb Fuel Leaks**

**Symptom:** During engine run or on start up the engine floods rapidly or prior to start fuel starts to flow up and out of the fuel vent line and or pools in the carburetor throat.

#### **Maintenance:**

To check float/needle valve shutoff on the bench, fill the carbs with fuel (I use a syringe) and a hose with a Tee and a mechanical pressure gauge attached to the fuel inlet of the carb and fill the carb and check for proper float operation and needle operation. I push about 8 psi into the carb with the syringe and note the pressure holds. If no fuel is running out of the carb vent line, or into the carb throat it should work on the aircraft. Now carefully keep the carb level, pull off the float bowl retainer and check the float bowl lever of the 912 series (you can't do this on a 914). If the bowl is about ¼ inch shy of the top and the floats are even, the carb float/needle are working.

On the aircraft, there is nothing wrong with using the electric boost pump for pressurizing the fuel to do this check. Although I have less control on the pressure (but more on that later). On the 912/912S equipped airplane which has no fuel pressure gauge, I use a short piece of fuel line and a tee to a mechanical fuel pressure gauge, from the engine driven pump to the tee going to the carbs. The pressure for a 912S should be roughly 2.2 to 5.8 PSI with the mechanical gauge running off the electric Facet FAC-40106 pump (normally called for by kit manufacturers) produces a nominal 2-7 PSI. To check the fuel return isn't clogged the fuel pressure should be around 5 PSI and if 7 or higher, the fuel return restrictor is clogged or low read below.

## **Fuel Delivery and Fuel Pressure Issues: Fuel Pumps:**

*Note: Fuel pressure should be monitored in a Rotax engine. It is not just for troubleshooting; it is an early warning device for fuel filter/return line blockage or carb float bowl leakage. If you do not choose to monitor your fuel pressure in the 912/912S at least check it with a mechanical gauge during the annual inspection. Never operate a 914 without fuel pressure monitoring instrumentation.*

### **912 and 912S Fuel Pressure:**

The engine driven fuel pump on the 912 series engines is a simple diaphragm pump driven off the gearbox. (See oil leaks below). One should never see fuel leakage from the small holes in the pump face and back, nor should fuel be evident in the vent tube of the newer pump. Fuel pumps do wear out. If any leak (oil or fuel) is detected, I strongly recommend changing the pump immediately. Fuel pressure must be maintained in a certain range (roughly 2.2 to 5.8 psi depending on carb and pump) on the 912 (7.26 psi is the updated manual on the new fuel pump). The 912 series carb pressure regulation is through a fuel bleed restrictor in the return line/fitting teed into the fuel plenum. The restrictor is 0.014 inches which is installed on the T located on the balance tube on all new Rotax 912/912S engines. It is preferred to mount the return and its restrictor high on the engine to allow vapors to exit quickly. The restrictor in the fuel return allows the pressurized fuel to bleed off a small amount of fuel and pressure from the manifold between the pump and carburetors. At low RPM the pressure is typically near 5.8 PSI, and at high RPM slightly lower around 4 PSI. In 2014, Rotax brought out a new fuel pump for the 912/912S series engines. *The new gearbox fuel pump delivers more fuel pressure than the old fuel pumps. I find that on some aircraft with the new fuel pumps, the restrictor installed may need to be enlarged from 0.14 inches to 0.20 inches so as not to exceed the carburetor pressure limits from idle to full power.* Just recently, Rotax updated the max pressure of the Bing to 7.26 PSI on the new 912S, which may allow a 0.014 inch restrictor to work but the aux fuel pump is limited now to 4.4 PSI. Heck of a thing. There was never a problem with the Facet 10106 4-7 PSI pump. With no flow restriction pressure is 2 PSI at about 32GPH, and if restricted will operate up to 7 PSI comfortably at a slightly slower flow rate. It also will pull nearly 36 inches of fuel vertically so running dry in one tank and switching tanks with the pump on will draw fuel very quickly. I'm sure changes will follow.

***Warning: Many low wing aircraft or aircraft with fuel tanks mounted low in the fuselage require an electric fuel boost pump in the event of engine pump failure. With both pumps operating one must ensure the fuel pressure does not exceed the Rotax / Bing carb pressure limits. Adjust the size of the fuel restrictor to meet the min and max limits prescribed by Rotax over the full RPM range.***

Europa and some other aircraft manufacturers use a larger restrictor called a FS02 which is 0.025" which looks like a push in type carb jet and differs from the Rotax 0.014 inch style which is factory pressed into a brass/aluminum nipple. Fuel restrictors should be mounted where they can be accessed and maintained easily, not in the middle of a return fuel line going back to the tank. (Don't put the restrictor at the tank or you must drain the tank to service the restrictor.) I press my restrictor FS02 or similar into a brass nipple when possible to prevent the restrictor from roaming around in the fuel return line. For

ease of service I mount the restrictor up at the Tee near the carb to fuel pump tee (See below.) If you do install the restrictor in the fuel line, put a hose clamp over the section where the restrictor is to secure it in place. (See fuel Return diagram below.).

**Warning:** *High fuel pressure in a 912/912S indicates a clogged fuel restrictor. Fuel can and will leak from the carburetor (look to see if fuel is coming from the vent tube) causing flooding and a chance for an inflight fire or engine roughness or failure. Never operate a stock 912 engine without a fuel return line.*

#### 912/912S FWF Fuel Return/Pressure

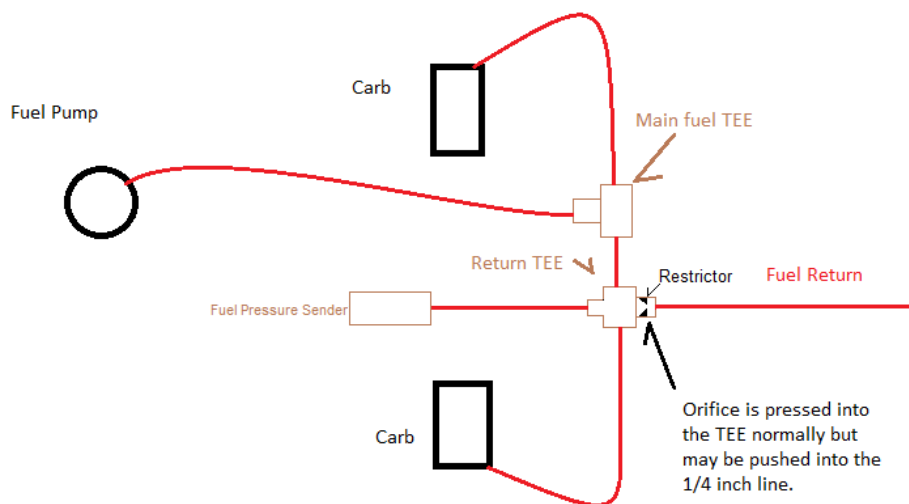

#### 914:

It is very clearly documented in the 914 Installation Manual how to install the fuel pressure and return lines on to the plenum. There can be no restriction in the 914 return line. The fuel pressure regulator adjusts/restricts the fuel return which increases the fuel pressure to the carbs to compensate for airbox boost pressure.

**Pressure Gauges:** Many have installed the UMA differential pressure gauge on the 914; I do not use these. If I suspect the fuel pressure is not working, I have a sender reading at my fuel pressure regulator and I can vary the air pressure to the regulator to see if the regulator is working and I can pinch off my return line to drive up the fuel pressure manually if necessary. See Phase of Flight/Takeoff later in this text for the 914 fuel pressure troubleshooting.

## Section 2

### Engine mechanical problems: Maintenance, inspection and service related:

**Note:**

*Some problems may require a major overhaul or specialized training to do properly.  
Do not attempt a major repair without proper training:*

**Annual Check Concerns:**

The Rotax Line Mx manual is a must read. Excellent procedures are found here.

**Compression Checks:**

During an annual type condition inspection many builders/mechanics will do the compression checks on a hot engine while draining the oil, as the oil change and compression check is part of the normal task of cleaning, leak checking and inspection process for an annual condition inspection. Normally I don't drain the oil first then with an empty oil system turn the engine doing a compression check, as you will get air in the oil lines while spinning the prop around for the compression check and that may force air in the oil lines which requires a purge of the oil system to prevent engine damage on start up. Prior to an inspection, I run the engine or fly the aircraft first to determine its normal engine operation (unless it is unsafe). After the engine run, remove the cowl and check for leaks and wipe the engine down again. If all looks good I run the engine again up to operating temperature and check for leaks (exhaust, oil, gas), and shut down, burp the engine to get all the oil in the tank and if all is well, change the oil/filter. I run the engine after the oil change is complete to leak check my work and shut down and burp it again. With the engine fully warm, perform a proper differential compression test with the proper orifice. Relax, no air from rotating the engine or the compression check can get into the oil supply system. Check each cylinder at top dead center IAW the Rotax line maintenance manual. Normally a differential compression will be 78+ over 80 for a new engine. Used engines of 3-500 hours are 75/80 plus or minus a couple. For a smooth-running engine, all four cylinders should be nearly the same pressure. An automotive style spark plug gauge type compression tester (the type you screw or hold into the spark plug hole while cranking the engine) only tells you that you have compression after a few rotations of the starter and does not tell you what component (i.e. rings or valves) is suspect and it is hard to see small variations between cylinders. The Rotax compression and carb balance tools are cheap for a tool, so buy a Rotax one.

**Culprit:** One of my cylinders is low by 5 or 10 psi. Let's say 3 cylinders are 75/80 and one is 65/80 but the engine is smooth. Don't panic! After the oil change, button the engine up and run the engine up to full power or even fly for a bit, shut down and perform another compression check on a hot engine. If the one cylinder is still low, with the prop properly blocked, and the offending piston at top dead center, pressurize the cylinder and listen by ear or stethoscope in three areas, namely the crank case, intake and exhaust.

**Leak detection sounds from the head during a differential compression check:** If the air can be heard leaking out of the carburetor ( pull the intake plenum off the carb to hear), you most likely have a dirty intake valve seat and the valve isn't sealing well. If

the air leaking sound is coming out of the exhaust (this is very hard to hear in a turbo and may require you to pull one exhaust tube in the 91X engines), it is an exhaust valve leaking. This is most likely due to carbon or a bit of lead buildup on the valve. Pull the valve cover and tap the offending valve(s). If it seals, you have confirmed you are getting dirty valves or seats. If the valve air leak doesn't improve, borescope the cylinder and check that the engine didn't have an over speed as the valves may have contacted the piston top and bent the valve or stem slightly (impact of the valve on the piston seen as a ring on the piston top. Have the heads removed and investigate if this is the case. If it looks good after a borescope, run the engine with Ethanol Mogas to clean out the lead and carbon and clean valves by running at max continuous power for a brief time or a flight. If cylinder pressure is still low, the valves may need a cleanup and lapping or replacement. A valve cleaning and lapping is an inexpensive job of under \$2000 by a professional or a Rotax dealer for all four cylinders.

**Oil crankcase leak sound during a differential compression check:** If on differential compression check, a cylinder is roughly 5 PSI below the other three, a common reason for this smaller difference on one cylinder is the ring gap of all three piston rings are nearly aligned. The piston rings will rotate in use and it is common to find one cylinder that has had this ring gap alignment happen. Run the engine after maintenance for a couple of flights and recheck. Normally it will clear, and pressure checks will normalize. If the air leak sound from the crankcase (heard through the oil tank) is substantial and the leak down check is over 10 PSI different from the other three, you have a problem. The piston could be damaged, the rings damaged, the cylinder is out of round or scored. Look harder with the borescope and check for cylinder scoring and the like. It could be just a cleanup of the cylinder and reinstall or a new cylinder, piston and rings. I encourage owners to take the engine to a professional to change the cylinder and evaluate the damage.

***Caution: Rotax engines should not leak oil, fuel or coolant, EVER!***

### **Oil Leaks:**

If your engine has an oil leak, immediately look for the source.

Visually inspect and mark or photo areas where the leaks appear.

Clean the engine very well. Allow to dry. Developer is a fine talc like material sold in spray cans for far too much money, but it is an excellent aid in leak detection. Developer works and allows the talc to stick to the engine surface to easily observe oil leaks. Spray developer or spread talc powder on your suspected areas.

Prop blast will make hunting for a leak, miserable. You have to cowl the engine to find your problem. Even with the cowl on, oil leaks may move forward or aft from cowl pressure and the low-pressure area of the prop hub and may cause oil to stream out from behind the prop or creep out of the top or bottom on to the cowl and streak aft. Oil may swirl inside the cowl and find new and unique ways to puddle. Using talcum powder or Baby Powder blows all over the place. You may need to spray a bit of tacky stuff getting it to stick or use tape and paper towels. It's a mess that way. Suck it up and just test a few times until you are sure where the leak is coming from.

### **Some possible leak sites:**

#### **Oil Pump:**

Occasionally an oil pump O ring may leak due to a factory install error. Install a new O-ring and coat the sealing surfaces with a thin layer of Loctite 515 on assembly. Allow 24 hours to cure. Purge the oil system and recheck up to full power. If the pump continues to leak after installing a new seal, something is very wrong. See case fretting below.

#### **Engine Case:**

Engine block heating bolts can cause leaks. Once the engine case has a factory bolt removed, the seal is broken, and those leaks are nearly impossible to reseal. Typically, guys in cold climates prefer a heater bolt, but at the high risk of case seal compromise and a case leak forever all you can do is try to fill the screw hole with sealant and re-torque. **I never recommend the heated case bolts. The pads work fine and easily fit on the lower side of the Rotax case and oil tank.**

#### **Heads and valve guide tube areas:**

Heads have two cap nuts under the valve covers that have no sealant. If you have a leak at the head lower bolts located in the valve cover contact the dealer and get a new cap nut. I coat the cap nut with 515 on its flange only and re-torque and that works fine. Only loosen and replace one head bolt at a time or you are loosening and re-torquing the engine needlessly. Valve guide tubes rarely leak on a Rotax, if they do, the head must come off. Not a fun job and prone to other mistakes, let the pros do it.

#### **Mechanical Fuel Pump 912/912S:**

##### **912 Fuel Pump and gasket:**

Rarely does the gasket on the 912S fuel pump leak, however, this may be a premonition of a failing fuel pump or damage. The head to exhaust pipe junction should be checked for leaks as a direct exhaust blast hitting the pump has been observed. Always inspect this area and cure any exhaust leak. Be sure the leak is from the gasket and not from the pump itself due to a different failure. The mechanical pumps are driven by a gearbox shaft lobe pushing a plunger and are a simple diaphragm pump. No oil or fuel should ever leak out of these pumps. The original pumps had no drain tube coming out of the pump, just an inlet and outlet fuel line and some holes in the pump body for observation of draining oil/fuel. If your older Rotax has been modified with the latest pump there is a drain line on the pump. No fuel or oil should ever come out of this drain or from the crimped or bolted body. Make sure the drain line is clear and vented to a neutral pressure area in the cowl so as not to affect the pump pressure. If only the gasket between the pump and gearbox is leaking oil, simply remove, clean, and replace the O ring/gasket and watch.

#### **Gearbox:**

Gear boxes sometime leak at the 6 O'clock position. Normally the gear box just needs to be pulled and the flanges cleaned and recoated with 515. Apply a bit more than a thin film at the 12 and 6 O'clock position. If the case halves are not even, get it fixed under warranty on a new engine. If equipped with a PTO watch the alignment of the PTO on install.

**Oil Tank:**

The oil tank fittings have changed over the years. Some are more like AN cone shaped fitting, and others (older style) are a round cup fitting. Either fitting type can leak. A leak in the supply or return line will pool oil on top of the oil tank top. The cup type seal may leak also. Again, clean, use developer or similar method and check your fittings properly seal. If the fittings have been distorted by over torquing the nuts, a copper repair flare seal may be available if the fitting is the AN style cone shape. If the fitting is the original cup type, buy a new fitting. Don't use sealant as a repair.

It is not uncommon for one or both oil tank fittings to loosen. After all, you do not want to overtighten and distort the fitting. The hoses pull on the oil fittings and can with vibration can loosen the fitting. Don't over-torque the fittings trying to prevent this. I put a hose clamp around the tightened nut as there is no drilled hole in the nut, then safety wire the clamp to the tank to assure the nuts do not loosen. Zip tie the hoses to hold them in place at the tank but allow movement from the tank to the engine to prevent the hose from twisting the fitting.

**Sensors:**

Check sensors and oil line connections for proper sealing and tightness. Use the sealant specified in the sender install/maintenance manual. Mostly Loctite243 today but some still use Teflon sealing tape.

**Coolant Leaks:**

50/50 Glycol will cause corrosion over time. When changing the hoses, clean the nipples of any scale, pits or damage from hose removal. Use proper clamps for the hose size. The head coolant nipples have O rings on a flange on the top, and some have sealant and just screw in as on the water pump and lower head. Use developer to determine where your coolant leak is, and remove, reseal and replace the hose or nipple seals which are leaking. Use Loctite 243 or the original 648 sealant and allow to cure before refilling the engine with coolant and running the engine. Always inspect hoses for heat damage from the muffler or pipes.

**Hose Clamp Problems:**

I still use my 1996 clamps supplied on my engine after two hose changes. 17 mm hoses are hard to find in the States and are normally heater hose made from common rubber. Rotax hoses work with the original worm clamps or spring clamps as both are high quality. If a clamp is suspect, avoid a Breeze Clamp with open slots in the clamp. Order new spring clamps or use a silicone hose worm clamp with a smooth inside to prevent cutting into the soft rubber or silicone hose.

**Water Pump:**

The water pump has one bolt that goes through the wet section of the pump at 6 O'clock and must be sealed properly. If a drip is evident at the water pump, use talc powder or developer to look for where the leak is. Pull the water pump, clean the seating surfaces. Check for casting errors in the stator housing and pump housing. Casting errors are not uncommon. If the long, wet section bolt is corroded, replace it with another stainless bolt. Pressure check the system by using a tight seal and 15 psi or 1 bar pressure source to leak check the cooling system.

If oil is evident in the water pump area, the rear main engine seal may have failed. I suggest pulling the engine and taking it to a certified Rotax repair facility if the rear seal is leaking. It takes a couple special tools, removal of the rotor/dynamo, water pump turbine and then the seal. Not fun. You may as well replace the sprag clutch also since it is all apart. Let the pro look and perhaps the seal may be leaking due to a poor casting or fretting in the case and you can't normally fix that.

### **Casting Errors:**

Both the stator housing, crankcase, heads and gearbox have been known to have casting errors that can cause a leak or in extreme cases, structural failure. Most of the casting failures are found early during leak checks on a new engine. Always troubleshoot leaks and document them with the dealer and determine if your engine has a warranty still on any component in question. You may get it fixed for free. Do not pass up a chance to document a problem. Some manufacturers ignore inputs, Rotax documents them. Especially problems from the recreational flyer as their engines are rarely stressed.

### **Engine Overheating:**

#### **Signs of overheating:**

Coolant will vent into and from the overflow bottle if boiling over.

Heat tape is available to check head overheating if your gauge is suspect. These tapes display a max temperature of the component. Use an external thermometer to validate readings. If the CHT gauge is climbing to over 245F (local coolant boiling begins about 245F on the CHT which is about 260F in the heads) and at 275F you are now fully boiling the coolant in the system.

#### **Typically overheating is due to at least one of the following:**

1. The coolant is not completely full. This is common after a coolant change and requires extensive ground runs or short flights to force out trapped air in the system.
2. Radiator cap leaking or the wrong pressure for the coolant.
3. Improper glycol mix (50/50 recommended)
4. Evans coolant runs hotter than 50/50 glycol by 15 to 20F.
5. The CHT probe on #3 cylinder is in close proximity to the exhaust pipe and the oil tank. This reflected heat is typically 15 or more degrees F higher than actual.
6. Radiator is too small or poorly ducted, so air is not drawn through it. If air can go around a radiator or cooler, it will. DUCT IT PROPERLY.  
(See Cooling 101 at <https://www.customflightcreations.com>).
7. Engine carbs set too lean, leaking air, or an after-market leaning device is set improperly.

#### **Solutions to overheating:**

1. Wrap exhaust pipes (especially #3). Rotax used to prohibit this. The problem was the exhaust pipes. They cracked anyway.
2. Correct ducting air leaks and ensure there is a significant draw of air through the radiator. Remember, there can be no gaps between a radiator and its duct all the way from the inlet front to back to the cowl exit. If there is FORGET IT! Your radiator will not perform properly.
3. Add fans to the non-ducted radiator if cowl design is poor to ensure a positive airflow through the radiator during ground and climb operations.



4. Enlarge or add extra radiator surface area if the original radiator is too small.
5. Improve cowl draw out the rear of the cowl to aid in radiator performance.
6. Set carb mixtures IAW the Rotax manual.
7. Improve cowl airflow over the cylinders by use of a plenum over the cylinders.

*Note: 90% of overheating in my experience is a bad cowl air flow design.*

#### **Gearbox 600-hour checks:**

I would recommend removal of the gearbox using the proper tool (a slide hammer purchased from Rotax) and sending it off to a Rotax repair center. The spacing and torque settings for the slipper clutch and bearing seats is easily done with the proper tools and a dealer rebuild is very cost effective.

Reinstalling the gearbox requires a small amount of time and technique. If a PTO spline is installed, its gear must be aligned carefully on install of the gearbox. Never try to just push on the gearbox and bolt it up. Once the PTO spline is aligned and the gear box is fitted, tighten the bolts and then rotate the engine by hand with the plugs out. If it doesn't rotate easily or seems locked as you pull down on the prop blade, STOP! Pull off the gearbox as the PTO spline is not seated properly. If you rotate the engine by force, you will break a small plastic cog in the gearbox, and you will have to have the gears pulled out again and incur unnecessary cost. Don't worry, the gearbox fix is easy and only one small plastic spacer will need to be replaced but it is the time, so do it right the first time. Also don't worry about damaging the PTO gear removing the gearbox, if you found you bound up the gears, pull it as it is fine. Just remove the gearbox, clean, put on more sealant and reinstall properly with the PTO gear movement meshed properly this time. When reinstalling the gearbox, always use Loctite 515 or as directed and apply a thin flat bead all around and especially on the upper- and lower-case split sections, to prevent oil leaks.

*If you don't know what I am talking about, fly to the dealer or if impractical pull the prop and engine and take the engine with gearbox to the dealer and let them do it. They will also take care of your SB, SI, and SL inspections if they are worth their salt.*

#### **Engine Case:**

I do not recommend an amateur try to rebuild a Rotax. There are too many special tools and fixtures needed and it is time consuming and easy to screw up. It is not rocket science, it just requires the tools, fixtures, precise measurements, time and technique.

I especially do not recommend cracking the case apart. Buy a short block if you have internal problems. The labor costs on cracking the case can be daunting. Pulling some components such as heads, cylinders or water pumps is not difficult and done with care and is something a knowledgeable owner can do.

## **Engine External Accessories, Sensors and Consumables:**

### **Exhaust:**

#### **All Engines:**

It doesn't matter what kind of aircraft engine you have, exhaust leaks are dangerous. In the auto world we worry more about corrosion than leaky exhaust joints as the heavy flanges and gaskets take care of most leaks. In an aircraft it is a different story.

Aircraft engines run at full power for relatively long times and 75% nearly all the time. Rarely are gaskets and flanges made large and robust due to weight considerations. The 912 Series Rotax engines have no exhaust flanges at the head nor do they have tight fitting slip fittings into the muffler. This is very dangerous, and caution must be exercised. The 914 has a slip joint system which is tighter but is more prone to cracks if not supported properly from vibration. Some manufacturers exclusively use slip joints in their exhaust piping but again, usually not at the head of the Rotax.

#### **Exhaust leaks:**

The 912S is a high vibration engine due to its high compression. This lateral shaking is high in amplitude and is tough on exhaust components, such as the joints, springs, down pipes, and mufflers of your exhaust. It is essential that the engine roughness be checked and solved, or the exhaust system will fail often. The 912 (80 HP) is not as prone to this shaking but bears watching as it often has the same exhaust system as the 912S. The 914 and Classic Europa exhaust are a different animal, but each has its own unique problems.

Any exhaust leak is bad. 1300-1500-degree F heat milling around the cowl at high velocity will burn through coolant and oil lines as well as damage components like the fuel pump, ignition modules and both carburetors. Exhaust jetting out of the pipe to head or pipe to muffler joints can hit the exposed oil, coolant lines, or the carbs and will cause burning, leaks, fire or boil the fuel in the bowl and cause rough and or lean operations, even engine failure. Premature failure of the ignition module or ground wires is possible also. Evidence of an exhaust leak problem is a tan/brown/black soot stain on the pipes or surrounding components. Many believe that the 912 series is prone to vapor locking. In my experience it has always been poor exhaust sealing impacting the carbs and or fuel pump. One way to check is to put heat tape on the carb float bowls and fuel pump and monitor.

Once installed, the exhaust system should stay put, that is it should not rock under the engine. If the exhaust continues to move during operation, you have a problem with the engine, or the muffler support. The CKT exhaust system is light, well built, and reliable, but if the engine is particularly shaky, it may move on its own, causing the down pipes to crack, and leaks at the joint to the muffler. Also common with muffler movement or leaks, one will see the head to exhaust seal wear, springs will fail, and or there is rubbing or cowl wear/staining or burning. Not even strapping the exhaust down will fix the problem of a shaky engine. Get the engine running smooth and properly fit the exhaust.

#### **Hanging the Exhaust:**

A common problem when hanging the exhaust is sealing the pipes to the head, and from the down pipe to the muffler. First the hanging. It is essential that the exhaust system be

assembled on the bench then put up under the engine and the pipes be fitted to the respective cylinder loosely. Never tighten the down pipes one at a time to full torque. This will stress that one pipe as the others are tightened and forced into proper alignment. This bit of extra tension will cause a stress riser and potential crack. Exhaust systems run temps from 1500F to outside temperature every flight. These constant heat cycles will eventually weaken the pipes and or muffler and a crack will occur at a stress point. To exacerbate the problem, it is necessary to weld EGT bungs, spring hanger brackets and drill holes for clamp on EGTs each of which are all stress risers.

It is essential to inspect a muffler system prior to installation. Every cone shaped head seal, and down pipe to muffler joint must fit properly. Correct any ill fitting joint. When hanging an exhaust, it is best to hang the unit from the studs and only snug (barely tight) the exhaust nuts to pull the conical exhaust down pipe to the head. Move the individual pipes and muffler into the desired position. Carefully look for any misfit of the down pipe to head and downpipe to muffler. Once set where it needs to be, work around the engine tightening the exhaust stud nuts until tight. Stress risers occur also around a welded EGT bung or for those with clamp style EGT the hole made in the pipe may start a stress crack. Always relieve any welded bung and debur any hole for an EGT probe. Lycomings, Continentals, Jabirus and any other muffler equipped aircraft engine gets exhaust cracks for the same reasons. That is why I do a 25 hour check while the oil is draining. Caught early, an exhaust leak is an annoyance. Left alone it will cause extensive damage. I do not fear wrapping the exhaust pipes with high quality exhaust wrap. A pipe that is exposed to high heat will soften normally and the wrap allows for slower cooling. Plus, there is a side benefit that the cowl temperatures will decrease somewhat from less reflective heat. Normally in aircraft we don't worry about reflective heat unless it is on our feet or burns the cowl or components. I found wrapping #3 exhaust down pipe lowers the reflective heat on the #3 CHT probe giving a more accurate cylinder head temperature.

### **Maintenance of the exhaust:**

Check the fit at the head to pipe joint after one hour and then every 25 hours for leaks. Never over tighten the exhaust studs and nuts trying to stop a leak from an ill-fitting/warped/badly machined head to pipe joint or prevent movement of the exhaust. It is the friction at the head to pipe joint that secures the exhaust system from movement on the 912. Never torque a loose exhaust stud. If confronted with a loose exhaust stud, remove the stud, clean and use Loctite 243 or similar locking fluid sparingly to reinstall the exhaust studs and allow to cure. The Loctite will allow you to properly torque your exhaust bolts during final bolt up. If the nuts are severely corroded, replace them, clean the stud threads or get new studs. Once the engine fires up, the Loctite 243 will fail eventually but we have not had a problem with the studs unscrewing unless the exhaust pipe (s) is moving on the engine. Those members of the department of redundant redundancy can safety wire the nuts to each other to avoid loosening. See below if the exhaust system is moving.

If the exhaust leak is at the head to downpipe joint, you can lap the joint between the pipe tapered flange and the aluminum head exhaust exit. Rotax does not use exhaust gaskets. Repair or replace pipes that have irregularities in the pipe sealing cone. If the head to exhaust pipe seal is slightly out of round or leaking, usually one can correct this through laptop machining (file it on the bench or your lap). The heads are aluminum so a little

lapping may be required for a good fit. Ensure the pipe tapered flange is round and smooth. Use valve lapping compound and while holding the pipe at the angle that it must exit the head to fit into the muffler to pipe joint, simply rotate the pipe a few degrees back and forth until you see an even mark all around the pipe and head indicating a tight fit of the pipe to the head.

Check the fit of the down pipe to exhaust muffler also. Loose fitting or heat warped down pipe seal to the muffler cannot be fixed easily. First off, the muffler manufacturers which use ball joints do not always have a convex joint on the muffler to properly seal the down pipe ball joint into the muffler. To combat this I have used, with some success, a Permatex muffler sealant paste which is water based and has proven to seal these mufflers to pipe joint leaks for at least 100 hours. If your downpipe to muffler joints are leaking, I would try sealant with new springs as it has been effective over the short term.

Always look for exhaust down pipe cracks. Especially near the EGT holes or welds as well. Replace the pipe or pipes if cracked immediately.



Springs are a pain. Normally a Europa Classic 912 Exhaust or 914 with slip fit pipes and or bolted flanges are no problem as the springs or clamps simply hold the two slip fit pipes together. Other aircraft manufacturers (Rotax stock exhaust muffler and Europa XS Aircraft included) use exhaust systems that hangs the muffler from the pipes on springs. The 912S tends to be rougher in its horizontal movement during start and stop due to the high compression. This causes the exhaust system to build momentum and move. The springs are designed to hold the pipe to muffler ball or cone joint very securely so as not to leak, but they will not secure the muffler or down pipes from moving fore/aft/or laterally. The manufacturers springs supplied with the muffler do a very good job of keeping the joints pulled up tight but as stated above they are not necessarily leak proof. With proper sealing and tight cylinder head to down pipe exhaust joint fit and stud torquing, the exhaust system should not move or leak at all.

Springs fail for any number of reasons. Any exhaust leak from the joint heats the spring, it loses temper, and will eventually fail. Corrosion in steel springs is common. Also, the harmonics of the engine causes a harmonic in the spring, which causes premature fatigue failure. But these things are fixable. For final assembly, always remove the exhaust and assemble the springs on to the down pipes with the whole exhaust off the engine. To do this, remove the exhaust system, rotate the pipe down to horizontal to loosen the springs. Replace the springs, rotate the down pipes back into the sockets (with sealant if desired)

and reinstall the system and wipe up the excess sealant before it dries. To prevent a failed spring from being a hazardous dropped object or FOD hazard, run a piece of .032 or .041 inch safety wire from the mounting hook on the muffler, through the inside of the spring to the upper hook on the down pipe and twist and secure. To prevent harmonic vibration or oscillation of the spring, coat the spring with red (high temp) RTV on one side to dampen vibrations. This greatly increases spring life, plus you can see where the spring failed and go back to the manufacturer. He may give you a new one.



Types of springs vary. One thing to be sure, the spring itself must be made very smooth. Any marks from tooling will lead to premature fatigue failures (a common problem with CKT springs supplied some 10 years ago until they began making their own out of stainless). If a spring failed, many owners went to the local motorcycle shop and bought 2.5-3-inch long springs with a simple hook on the end to replace their original springs. These hook style springs can be installed by simply pulling up on the spring with a spring tool (a few loops of .040 safety wire with a wooden handle will do also) and hooked in place without removing the exhaust. After all, if the muffler system wasn't leaking or broke, why take it apart for a single spring. If more than one spring has failed, investigate. I prefer to replace the springs with the full compression spring normally supplied, as they last longer, but it is a heck of a pull to install a broken one.

Again, the quality of the spring is important. Factory springs normally are a compression spring (they look like a tailwheel spring) and must be pulled to near its maximum to install. Any good spring will work for a temporary fix. The failure rate of the simple hook springs seems to be higher than the factory aircraft stainless springs. The motorcycle springs seem to favor failing at the hook unless overheated by an exhaust leak near the middle. Stay away from simple carbon steel springs as they rust out very quickly and fail. Stainless springs last quite a while, but still need inspection and occasional replacement.

If you need a quick fix for a pipe with a broken spring, pull it up taut and safety wire it in place with .040 safety wire looped 4 or more times. It will hold for a short flight. It is best to replace the spring ASAP. It is a tedious job to pull tension on the spring, while

maneuvering the loop of wire puller to get the new spring hook in place. It takes two people and 4 hands. Carry a spare and practice as a new spring is the best fix.

## **Engine Sensors:**

### **Oil Pressure:**

Oil sensors for the Rotax can be problematic, especially on the 912S engine. Rotax uses a simple VDO sensor of 10 bars or 150PSI. At the factory they install a brass ring on the VDO sensor to reduce vibration induced failure of the internal components. This failure and the brass ring fix has gone on for years. Many have opted to run a fitting from the oil pump NPT fitting and run a line connecting it to a sensor (with a ground and sender wire) mounted on the foot well. Honeywell makes a very nice sensor as do other manufacturers. Rotax dealers sell them as a kit now. I use a stock VDO replacement sender should mine fail. I heat the old failed Rotax supplied sensor with its ring and remove the brass ring. I clean the brass ring sealant a bit and use red high temp sealant (RTV) or Permatex high temp silicone to secure the brass ring to the new sensor then install the sensor on the engine. Good for another ten years!

### **Oil Temp and Cylinder Temp:**

*Note: The Rotax oil temp and cylinder temp senders are the same, so if the oil temp fails, swap it with the head sensor to troubleshoot. Use a drop of Loctite 243 for the oil temp probe sealant.*

The VDO cylinder head temp sensors work quite well and seem to last forever. The problem is, Rotax uses their own thread pattern on the temp sensor so the cost is way up there (\$180 vs a \$30 VDO sensor which uses an NPT or metric type thread pattern). The ring style thermocouple sensors (as on many engine monitors such as Grand Rapids) work well but are attached on the outside of the cylinder head. I tend to prefer the Rotax sensor. Now with the new head design, the CHT sensor is imbedded in the coolant flow, not just an air chamber in the head.

*Note: The accuracy of most VDO senders and gauges is not very good. They tend to read oil pressure on the low side and temperature on the high side, which is safe, but not terribly accurate. ALWAYS CALIBRATE YOUR GAUGES SO YOU KNOW THE GAUGE IS ACCURATE. Most gauges read within 5% and are dead on in the middle of the range. VDO is not as accurate as I like but is tolerable. It is not uncommon to find the VDO oil pressure gauge reading 30 PSI and a direct reading gauge reading higher even as high as 15 PSI higher than the VDO. I've tested the CHTs at an actual 100F and the gauge reads 100F, at 200F it read 230F, and at 275F was reading 300F. Again, it reads high on CHT and low on oil pressure. Safe but not accurate. Always do a check of the sensors for accuracy! Boring, but informative.*

## **Mechanical problems evident to a pilot which require grounding and dealer servicing:**

### **Case Fretting:**

Some of the older Rotax engines have exhibited problems with the internal engine flanges flexing and wearing at the bearing seats. New cases have reinforced case bolt fittings and flanges. These flanges are built into the case halves on the crankcase and hold the bearings for the crank and cam shafts. The typical case fretting problem occurs in the pre- 2004 912S and 914s engines which originally was engines operated at full boost for long periods or high takeoff and landing cycles such as in glider tow. However, I found that the case fretting started for most recreational fliers with a problem in a casting.

Case fretting or internal failures are evident when burping the engine prior to flight. If the initial force required to move the propeller blade is high (I think the new manual says 100 foot pounds), then seems to move freely after breaking free, the case exterior flange or internal supports are fretting or wearing against the other case half causing the bearing to be squeezed on one or more of the bearings on the crank shaft. Your oil system will not show high iron content as the bearings are tight, but not spalling. The original SB indicates that cracks can be seen at the case bolts with case fretting. It doesn't always show there. Look for oil leaks on the case split and between the cylinders on top, bottom and between. The engine flexes during running and it is very likely that cracks will form and be evident during oil changes as oil leaks or as a wet spot on the case. This leak is a normally a very fine almost invisible crack in the case from the flexing of an internal flange. It also can be seen as leaks from the cylinder to case or head to cylinder areas, as well as the oil pump. The case fretting or failure will cause many other symptoms such as numerous scattered oil leaks, strange vibrations or performance problems. I've only seen it once, and the engine ran just fine. It was very stiff to pull the prop initially during the burping action, but the engine started and ran well. However, it was a ticking time bomb.

## **Consumables Issues:**

### **Coolants:**

Ethylene Glycol is fine however, use the factory 50/50 premix or use distilled water rather than tap water. The heat transfer rate is quite good for a glycol/water mix. It is true that local boiling occurs in the head at about 260F and I know that every engine I have done, if I let the head temp get above 245F, the coolant expands in the bottle some due to the Europa XS cooler being a bit small for high power operations, so the coolant clearly begins boiling slightly in the head. The Rotax stock radiator is fine if ducted properly but is still a bit small for extended ground operations or long full power climbs. The BTU transfer rate of a 50/50 mix is excellent, but the glycol cooler in many aircraft must be sealed very well so all the air goes through the radiator/coolers, and the climb speed kept higher at around 90 to cool properly in a constant climb up to 10,000 MSL. The bumper with glycol is you should change coolant every couple of years and you will see at the 5-year hose change some corrosion on the nipple ends. The new extended life mixture can go 5 years between changes and has less corrosion. Check your pressure cap

from time to time, as they tend to last only about 5-10 years before they lose a bit of pressure.

Why use glycol rather than Evans waterless coolant? So, I don't have to change radiators and or water pumps to meet my cooling requirements of 25 minutes on the ground then takeoff and climb to 10,000 feet on a warm day. Waterless coolants such as Evans have a lower BTU transfer rate by as much as 15-20% less than an equivalent 50/50 glycol, and some brands must be watched as the additives they add can attack aluminum. However, you can go with a lower cap pressure and corrosion should not be a problem ever. I used Evans NPG+ for a while and it works well, but the cylinder temps were uncomfortably high and there was little chance I could go 25 minutes on the ground without hitting 250F on the ground and no way to get to 10,000 before hitting 275F. I needed either a larger radiator and or larger water pump to keep the temps down in my southern climate. The lower heat transfer rate in my opinion makes an Evans type coolant impossible in an XS Europa and many other Rotax powered aircraft without modification. If your aircraft manufacturer does not duct the radiator, cooling issues can occur. Review Cooling 101 on my website.

**Radiator type Pressure caps are important:**

.9 Bar for Evans only

1.2 for Glycol always

**Fuel concerns:**

*It is the pilot in commands responsibility for the fuel in his aircraft!*

The FAA, various experimental aviation outlets and organizations as well as the European Aviation Safety Agency have produced pamphlets and postings on using auto fuel and ethanol laced auto fuel in aviation. Auto fuel varies from country to country and it is difficult to determine octane ratings when all you have at the pump is REGULAR/SUPER/SUPER DUPER/V POWER/XS280 and other such pump indications. I will summarize what I have learned and experienced.

*Note on Terms:*

*ASTM D2699 and ASTM D2700 are standard methods applied to measure the research octane number (RON) under mild conditions of operation at 600 rpm and motor octane number (MON) under severe conditions of operation at 900 rpm respectively.*

*The Octane number of gasoline is determined in the laboratory tests using a standard single-cylinder test engine having a very sensitive knock meter. The tested fuel knocking is compared with mixtures of iso-octane and n-heptane of various percentages used as a reference. That means if the fuel has the same knocking characteristics as 90 % iso-octane reference fuel then the tested fuel has the octane number of 90.*

*Methods of displaying octane is done differently country to country.*

*Europa uses the RON rating which is more accurate to me.*

*USA uses the POM or Pump Octane Number which is an average  $(R+M)/2$  which will be a lower number. Example 95RON in Europe is equivalent to 91POM in the US.*

*Research your fuel if using MOGAS.*



*Warning: There is a fueling fire hazard using refueling containers you must be aware of. Always ground the jerry cans on the ground during filling and ground the aircraft and fuel can as well as yourself prior to fueling due to static electricity. I can't emphasize enough that Auto Fuel "gas station" filtering is suspect and using refueling containers can contaminate the fuel system. Use of MoGas from a reputable gas station and using "Jerry Cans" (Plastic or Metal) which are clean, along with a final fuel funnel filter and proper grounding is safe but caution must be exercised. See my paper on refueling aircraft available on my website.*

**Aviation fuel (AV Gas) also known as 100LL :**

**Pro:** Starts fast, found at all airports (manned airports anyway) never has an octane issue. Airports have very efficient fuel filtration for 100LL. World wide standard for octane and additives.

**Con:** More expensive (although fuel is the cheapest running cost on the Rotax), lead reduces time between oil changes to 25 hours, and gray nasty lead soot gets on the fuselage and in the engine. You must add an additive (TCP or Decalin) to prevent lead from plugging everything up on the inside of the engine oil system and dirtying up the valves. Approximately every 150 to 200 hours you must clean the lead out of the oil can. Gearbox oil contamination reduces the gearbox overhaul time a bit from about 600 to 500 hours. Valve seats can get sticky without the TCP additive, so add it religiously. TCP does not hurt the fuel system when used properly. Same goes for spark plugs. You can see the lead deposits on the plugs and cleaning is a pain. If you borescope the cylinder you can see small lead drops on your pistons, valves and plugs. Yuck!

**Auto Fuel non ethanol fuel known as MOGAS:**

**Pro:** Cheaper than AV Gas, burns cleaner. Oil change interval 50 hours

**Con:** Octane ratings differ from country to country and refiner to refiner. Difficult to find 94 RON octane for the 914 (91AKI rating required) or even 92 Octane (91AKI rating) for the 912S. Pay extreme attention to the Octane rating of your fuel and ensure it is fresh.

If left to sit for a couple months, the octane rating of MOGAS drops as the additives absorb some water which degrades the fuel. Most pilots cannot hear detonation in a 912S or 914 but it leads to a serious amount of damage if low octane fuel is used even for short periods of time.

Any MOGAS is great for the 912 (80HP) as the engine is good down to 87 Octane (The engine normally lasts forever on this fuel).

Only buy fuel from hi volume gas stations to prevent poor grade crossover and water contamination. Using MOGAS requires trudging around with jerry cans. There is a fueling and fire hazard using refueling containers and filtering is suspect at the gas station pump unless using a reputable gas station to fill from. I strongly recommend using a filtering funnel when fueling from "Jerry Cans" or directly from the gas station pump.

**Auto Fuel with 10% or less ethanol:**

**Pro:** Cheaper to buy. Farmers are happy selling ethanol. The gas stations get a kickback. Octane levels are higher. 93, 90 and 87 octane (RON) are available at many of

the fuel stations. Use the highest octane rated premium fuel for 912S/914. Any octane will run in the 912 above 87 RON.

**Con:** Higher octane is available with ethanol, but fewer BTUs are available, so fuel burn is a bit higher for the same power setting of RPM and MP. Avoid long full turbo climbs in the 914 if octane is suspect. There is some concern with fuel vaporization at altitude, but I have not experienced that to date. Old gas is a serious problem. If the fuel is more than three weeks, the premium fuel octane rating of ethanol laced fuel drops to basically 87-89. Again, great for the 912 (80HP). Ethanol absorbs water and is damaging to all rubbers, and epoxy for sure. Even Pro Seal type fuel sealants are degraded by ethanol. The ethanol fuel turns milky in modest humidity in just a month due to water absorption. The fuel to water layer starts growing brown stuff in the tank after 6 months and your fuel system is now compromised and must be completely overhauled. Always drain out ethanol laced fuel, if the aircraft will sit for longer than a couple weeks. (Dump it in your automobile.) Mogas without ethanol should not be left to sit more than a few months in a fuel system, especially without a fuel stabilizer. If storing an aircraft for more than a couple months, drain the tank of Auto Fuel, then fill with AV Gas, run the engine with AV Gas. Use Stabil or similar storage fuel additive with AV Gas to prevent wintertime water condensation in an unheated hangar and to prevent condensation water damage in your float bowls and pumps. I add Stabil as directed, then run the engine using both pumps and change the fuel selector so as to get clean gas with Stabil throughout the system, then shut off the fuel valve and main fuel pump (914) and let the carbs run dry. The carbs are never completely dry of course but Stabil coats the inside of the bowl and corrosion has not been a problem using this storage procedure even in high humidity.

Components in the carbs suffer under ethanol laced fuel. Corrosion in the spring pin beneath the float valve is one area. The throttle shaft O ring dries out and begins to crumble causing an air leak. Corrosion due to water absorption in the bowl is a two part problem. The small orifice for the low speed side will clog with corrosion and idle gets very hard to set. Obviously, corrosion of the aluminum bowl itself distributes flakes of aluminum oxide through the fuel jets causing wear.

As for vaporization rates of ethanol fuel in carbureted engines, I believe this is not a significant issue. See flight operations section for examples of vapor issues.

### **Oil Types:**

Aeroshell Sport Plus 4 is a specifically formulated oil for the Rotax. It is just a multi blend or semi-synthetic oil. Use it with AV Gas or Car gas.

Mobile One Racing Motorcycle oil MX4T also known as RACING 4T synthetic motor oil works great. It should only be used with unleaded auto fuels.

### **Oil Specifications to consider when using other manufacturers:**

Rotax recommends using a high quality, major brand, **4-stroke motorcycle oil** with gear additives and “SF” or “SG” API classification.

The gear additives are required to withstand the high stresses in the reduction gearbox. The “GL4” or “GL5” specification is recommended.

## **Oil Filter:**

I use the Rotax oil filters as any oil issues will be questioned on any oil related problems without it. Other manufacturers make Rotax engine specific filters with the specific pressure relief valve requirements such as the Tempest AA825706 and others. I've tested one and they seem to do the job. I generally do not use them as it is a bit longer and too close to the exhaust pipe for my filter wrench. It does have safety wire fittings.



## **Caution in oil changes:**

For a simple drain, immediate refill and oil filter change, the oil system is not open long enough to require a purge of the system. If the oil system has been left open (oil filter off for a long while, oil feed line opened or the engine turned with the oil feed tank empty, or filter off ) I recommend you do a pressure purge, write it up in your logbook that the oil pressure purge was accomplished, and the hydraulic lifter check had been done or your warranty may be voided if you have any internal problem with the engine...

## **Airframe manufacturer problems engine related:**

### **Throttles:**

**Symptom:** The throttle cables always hang up and don't work in unison. The throttle cables don't seem to be able to push the throttle open or the springs seem to be weak:

### **Carb Throttle Maintenance:**

The springs on the carbs should not be tweaked or modified, leave them alone. If the throttle arms move freely and don't hang up, it's your cable installation. Many have made up solid wires and other things, for a better push pull operation, but I have no problem with the bicycle cables used by Europa or other manufacturers. Keep the bends long and loopy and do not fasten the throttle cables with zip ties or try to lock them in place. Any sharp radius turns, or tight bindings will prevent smooth operation and idle setting difficulty. (Not unlike a bicycle shifter cable.) Don't cut the cables unless you have the proper equipment and cable ends. Care must be taken to cut the sheath and seal the cable without burrs. Don't over tighten the cable pivots on the throttle arms. Just tighten until the cable slightly bows from the tightening or is just snug. Every oil change lube the pivots at the arms.

*Note: The Europa mono wheel and other aircraft firewall penetration for the throttle cables almost guarantees a cable binding problem. Much care and planning are necessary to fit the cable over the bungee and that short bend up on exit out of the firewall, then make the S turn bend around to the carb as it is a tight installation.*

*Technique: Run the cables down and offset from the bungee and then smoothly up around the engine frame and loop smoothly up to the carbs. This has been a great problem and requires new and unique ways to run the cable through that low on most firewalls, clear other items, and still make a smooth loop. I have found that running the fuel line, choke and throttles through one hole helps with the cable runs, limits the number of holes in the firewall, but forces a great deal of planning that is well worth the time.*

Build your dual cable throttle quadrant right. Start on the bench. The cables should not flex or drag on the cable sheath threaded end inside the quadrant. Pay attention and shim your cable sheaths to be as perfectly aligned as you can. If one cable is angled up or down, it will not operate exactly like the other. The 914 throttle housing in the cockpit should have a small detent installed in the throttle at 100% throttle. (This is about 2.3 inches from idle as the total throw is 2.66 inches). You should see 34-35 inches at the stop of a 914 and must push the throttle handle slightly outboard to go to full turbo (38-40 inches). For both the 912 and 914, there must be a stop for idle. A metal tab can be used for the stop and it can be removed, filed and reset after a carb rebuild or tune, as well for minute idle throttle changes. I have a screw in the back of the throttle for the adjustable throttle stop set. Use an AN525 10R8 or similar screw and rivet a nutplate to the back of the fiberglass throttle molding to make an adjustable idle stop.

**Basic Throttle Idle and 100% Detent Stop**

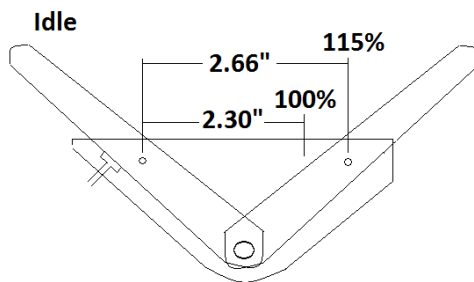

Always build your cable box and install your cables and operate them on the bench before install to assure alignment and cable function. Once installed in the airframe but not hooked to the carb throttle, the cables should move smoothly in and out as they did on the bench. With no spring to pull the carbs forward, this pre-hook-up check will tell if your throttle run is free from binding. If all works well prior to cable to carb connection, you will have trouble free throttle operation.

***Note: I never zip tie my cables to hold them firmly attached to anything. Every mechanic wants to secure these lines. If they work on initial install, and with the firewall attached, don't fool with it.***

Never use the Bing idle stop on the carb as your throttle stop. It will bend easily and eventually the carb balance will be off because of it. Fab a throttle stop on the cockpit throttle.

**Choke or Enrichening circuit cables:**

**Culprit:** The choke pull knob supplied is too stiff to operate. The cable moves fine without being attached to the choke arm. The choke arm works fine also. The tension on the choke cable going through the brass 90-degree tube is dragging in the tube on top of the carb and that is where the resistance is coming from.

**Maintenance:** One installation note is for the installer to pre-bend the choke cable ends to be nearly the same arc as the tube. Installing the choke and twisting the sheaths around during install is a common problem. So, don't do that. To improve the cable drag through the brass tube on top of the carb, use an old wire to burnish the inside of the tube making it smooth. Make nice wide loops in the cable going from the choke knob to the brass carb cable tube. Technique, for long choke cables, run the cable from the right carb to the left in a straight line so the cable has limited bends at the end except for the one in the tube. Don't shorten the cables, just run the right one to the left carb and loop back to the left carb copper tube. Thread the cable into the choke arm. Lube with graphite. Safety wire the sheath to the Rotax cable tube with .020 wire to hold the end of the sheath to the copper tube fitting. Affix the cable to the choke arm and check. It will be firm but should move freely. Every year use some graphite lube in the tube to help it slip if it gets sticky. See photo below.



*Note how the choke cables run from the firewall across the top of the engine. I safety wire my cable sheaths to the barb and lightly zip tie the choke.*

If the knob pulls off, remove the knob, and redux on. If you don't want to Redux, then remove the knob, drill through the sides of the knob plastic and brass and tap in for a 3/32 or similar set screw on each side. Clean the threads after tapping and reinstall. Set the set screws and it is trouble free. Another neat handle is to make a T handle. That is in another paper on my website.



## **Part 3.**

### **Common Problems Associated with Phases of Flight**

#### **Ground Operations:**

##### **Starting Issues Cold and Hot:**

Typically for a fast start, the Rotax 91X must make at least 300 RPM to start quickly (the Rotax book says 250ish is necessary for spark, but that is the minimum). If the battery is weak, the main engine ground or starter cable ends are loose, or the starter is deficient for any reason (armature damaged or greasy) and you don't get 250 RPM minimum or 300 preferred, the plugs won't fire strongly. If you believe your starter is OK, look hard at your minimum battery requirements for a successful start. Normally a fully charged battery will be close to 12.8 volts. During cranking, if the voltage drops down to about 9 volts, it may be time for a new battery or a full battery recovery. A 912 and 914 will catch if you barely meet the 250 RPM and normally stagger to life. The 912S on the other hand may fire and kick back which is extremely hard on the sprag clutch.

First, keep your battery up at peak charge. If the battery voltage is 12 volts, it is difficult to get a good start with a low torque starter. A higher capacity battery may be the answer or perhaps replacing the low torque starter will be best. The high torque starter will successfully start a Rotax if the battery is slightly weak (12 volts). If you need a jump or boost to get a quick start every flight, your battery may be failing, take the battery to a shop and have it tested.

Next, check the battery to solenoid to starter cables for good solid connections and make sure they are of proper wire size (normally a #4 cable) to get juice to the starter. If you are concerned that your AGM battery is too deeply discharged, AGMs are pretty good at coming back if deep cycled and properly recharged, so have your dealer give it a try.

*Note. Your Rotax voltage regulator only puts out 13.8 volts so a Odyssey battery only gets partially charged during flight operations. The AGM batteries require specific charging regimens. The Odyssey takes a charge quickly but likes to be spiked at 6 amps at 14.7 volts during charge then back to 13.6 and float at that for 8-10 hours. If the battery is down to 10-11 volts, it will take longer than 12 hours to get a full charge using a proper charger. If doing it yourself, check the battery is not getting hot. Typically, these batteries will last years with the proper charger. The typical trickle charger is not the charger of choice. Get a charger designed for AGM batteries and battery tending (float charge) and if your hangar has power, purchase an AGM battery tender to keep the battery topped off. These chargers are solid state and not cheap, but neither are batteries nor is being inconvenienced by a plane that won't start. See your battery manufacturers recommendations. You may also want to consider upgrading your Ducati to a B&C or similar voltage rectifier to get a higher voltage for in flight charging.*

*Disclaimer: Lithium Ion batteries are terrific for many applications. I do not have experience over the long term with these batteries. The main reason for my caution is the charging rate circuitry necessary to prevent thermal runaway, battery fire containment and best practice location for the battery which assures safety in any failure mode is*

*rather vague. I want a battery that will not compromise the aircraft or crew so it must meet my overly cautious concerns, and price point. The Lithium Ion battery manufacturers have made great strides and in 2018 the US NTSB began a review of requirements for Lithium Ion batteries in general aviation aircraft. Certifications are starting and I will wait for their recommendations. I will not discuss the use of Lithium Ion batteries in this document even now in 2021.*

If you can't tell how fast, your starter is turning your engine, monitor your tach. Hopefully you have an EFIS/EIS that does not blank out on start. Backup batteries for the EIS is very nice option to have. If it is cold and you suspect slow cranking check your voltmeter while cranking. If the cranking voltage drops to less than 10 volts, the battery is probably OK, but a jump or battery boost may be necessary. I keep an old Shumacher auto battery charger that has a 50 amp jump start feature at a steady 12 volts. It is \$50 and is great for a slightly slow cranking aircraft. Sock the amps to it and if it doesn't start, it is not the battery.

### **Plugs:**

I get irritated that guys don't change the plugs or properly clean them and then expect a low voltage starting system to spark the engine to life. Clean, fresh plugs are essential for hot and cold starting. When prepping for the flying season, install new plugs. Carry at least 4 spares to put in the top if cross country.

**Hot starting:** It is very easy to flood a hot engine and prevent the engine from firing if the choke is used. Again, a good starter rotation is imperative as is spark. The 914 main boost pump and fuel pressure regulator prevents true vapor lock. Cool fuel is circulated quickly through the system and any vapor is flushed away by flowing fuel. The 912 can have vapor lock on a hot summer day on a quick refuel stop if the fuel system is not installed IAW the Rotax Installation Manual. If the fuel restrictor is not clogged, the carbs don't over pressurize normally to flood either. The 912 procedure to turn on the Aux boost pump for 3 seconds to pressurize the fuel system will normally purge the vapor in the lines and prime fuel to the main pump. Silicone heat shielding and keeping the fuel lines elevated off the engine is a great help where summertime quick turn around fuel stops are planned. Open your cowl access doors is also a great help.

**Flooding:** A properly maintained Bing carburetor does not flood unless over pressurized by the fuel pump (sinking floats may cause flooding). On a hot engine, turn on the boost pump, **DO NOT USE THE CHOKE**, crack the throttle and engage the starter. If the engine does not fire, ensure you have good cranking voltage and RPM. Open the throttle fully and crank the engine. You do get higher cranking RPM if the throttle is fully open with the low torque starter. You also allow more fresh air to purge the cylinders of raw fuel. When the engine fires, you must rapidly retard the throttle. If flooding is suspected, you can continue to crank with the throttle fully open, but if through finding a gas smell and partial starts that belch black smoke, open the cowl and inspect the carburetor/fuel regulator for leakage before continuing. Allow the engine to cool, check the plugs, get a battery charger or jump and try again.

**Cold Starts:** If it is very cold, i.e. below freezing, preheat the engine. One way is to put a large quilt over the cowl and put a 100Watt bulb in the inlet and let it set overnight. If you are worried about your cowl getting burned, make sure the bulb has a shield to

protect the fiberglass from bulb heat. Or, as we did in the Midwest, we drained most of the oil and kept the oil and battery inside nice and warm, then filled the engine and installed the battery before attempting to start. We hand propped the engine to move the oil through the engine and then started it. Watch for excessive oil pressure on a cold engine after start as you can blow the oil pump seal.

**Fuel:** Cold weather starts are improved using fresh Premium Fuel or 100LL to assure excellent vaporization. If using ethanol laden gas, any water will be absorbed by fuel more than a few weeks old. Old ethanol laden gas will have a very low octane and vaporization and may have water/slush in the tank which compromises starting and can cause detonation and fuel filter clogging once the engine starts. The Rotax 912 and 912S with the plenum entrance on top of the cowl are easy to shoot starting fluid on to the filter and help it fire up. The 914 is not so easy. Should the starting fluid be necessary, (which I'm told is necessary for starting when well below the freezing point) it can be shot into the turbo inlet, but is best applied by removing the cowl, and injecting directly into the plenum through the air pressure tap. Start the engine and allow it to warm up then put the plenum back on and cowl it up. UGH. I prefer to heat the engine and charge the battery, fill with Av Gas, use a high torque starter and just pull the choke and start.

**Kickback on attempted start:**

Kickback of the engine is to be avoided at all costs. If attempting a cold start, and the engine kicks back, you have the first clue that you need starting help or you will destroy your sprag clutch and miss a month of flying and a couple of thousand dollars. Heat the engine up, use good gas, get a charge or boost on the battery if your engine is prone to a kickback when cold. If you have kickbacks that started slowly then became routine on start, your sprag clutch is starting to fail, so get the sprag clutch replaced. The 912S is rarely going to go 600 hours without needing a sprag clutch replacement in a cold climate unless precautions are taken to ensure a crisp start. That means high torque starter, good fuel and plenty of battery power.

What causes the kickback is a cylinder fires well in advance of Top Dead Center (TDC) and the engine kicks backwards and the clutch slips. This kickback can be caused by two things. Either the ignition module or sprag clutch slipping.

The older Rotax (prior to the smooth start ignition module) engines have a fixed ignition advance (22 degrees for Circuit B and 26 degrees for A module normally) (automatically controlled on the 912iS). You can see this on the flywheel ignition pickups. To improve starting, the ignition modules have a retard circuit. This is well documented in the Rotax 912/914 Heavy MX Manual section 74. Basically, it retards the spark to 3 or 4 degrees before TDC for 3-4 seconds from rotation start. Unfortunately, during a cold start the engine may not start in that 3-4 seconds and it will revert to the 20 some degree advance prior to the first cylinder firing. When the engine does fire, it will most likely kick back.

The smooth start deleted the timing circuit and put in an RPM switch in the circuit to keep the 4 degree advance until the engine reaches between about 650-1000 RPM which is well above the sprag clutch kick out and starter release. Once the RPM kick out limit is reached the ignition advances to nominally 26 degrees, making for a kickback free start in most cases. Should the ignition module RPM limit or timing circuit fail, the engine would be stuck in full advance which would definitely cause a kickback. The only



recourse was to replace the failed ignition module. Finding the problem ignition module meant attempting start on only one circuit (normally just grounding out one circuit at a time) and seeing which started better.

An ignition work around for the older timed circuits was to cut out the A ignition on start. The lower 22 degree before TDC allowed fewer kick back episodes. One needed either two ignition switches and a separate start button or for those using the ACS ignition switch, they were forced to wire the A mag to the delay on start pole on the switch so only the B circuit worked while the start position was activated. This was very frustrating to troubleshoot and the on line forums went on and on. Once the failed ignition module was found in either case above, it required the failed ignition to be replaced. If neither module made the start easier, then the only other remedy was to replace the sprag clutch.

In the field, the easiest way to check if the start circuit has failed is to simply disconnect A module ignition lead (from the start/ignition switch) and ground it. Start the engine cold. If A is OK, try the same with the B module. If B module is OK also or it still wants to kick back on either of these, it's the sprag clutch. Most mechanics believe as I do that ignition module failure is rare. Go straight to the sprag clutch. Especially if it has slowly developed a kick back problem over the summer then really got bad in the winter. If the owner is stuck with a low torque starter, the only recourse was to change the sprag clutch if kickback was a problem, keeping the battery well charged and the engine and battery warm.

#### **Rough Running after a cold start:**

After engine start, the engine does not run smoothly unless advanced to above 2000 RPM. Once the engine starts using the choke/enrichening circuit, the throttle should be opened above 2000 to but not over 2500 immediately until smooth while slowly releasing the choke. If the engine is still very rough, after running for a while, turn off one mag at a time and check if the engine still runs rough on each mag. If mag drop and roughness is the same, let it warm up at 2500 RPM and investigate. If the engine is fairly smooth, but the ignition check RPM drop is out of limits before takeoff, it is fuel/carb related. If during the check, the roughness is significantly different between ignitions, then it is most likely dirty plugs or a slight chance of a coil problem. Perhaps you are lucky, and it is both carbs and plugs. In any case, run it up to 5000-5500 or full power and burn off the plugs and re-check. That clears many plug/ignition related problems. However, if the engine dies completely on one of the mags, it is likely an ignition box or wiring problem, if it is still quite rough, now you have carbs, plugs, and ignition coils to check while out in the cold. Find a temperate hangar to work in.

#### **Run-up Roughness:**

If the idle is smooth, and during the ignition check at 4000 RPM, the drop is still out of tolerance or slight roughness is encountered, it's usually the carbs. They are out of balance, have a bowl leak, or your plugs are fouled due to lack of running and oil/gas/carbon buildup. If one ignition is smooth and the other rough in a 912, it is most likely plugs, in a 914 it may be the lower plugs are flooded by fuel or oil. In either case, run up to 5000-5500 RPM to burn off the plugs and do the mag check again. If it is still out of tolerance, it's the carbs. If it smooths out, and ignition checks are good, go fly.

**Charging is weak:**

If the Ducati does not charge at 13.8 volts, or near there, at 5000 RPM troubleshoot your system. Abort and return to the hangar and check the C voltage first. It should be at battery voltage, at all times. If below 13.8 at the C terminal with the engine running, correct your C or field circuit. Never fly with a suspect battery or a charging system that is faulty.

**Ducati Regulator fails at a high rate:**

Cut your amp load as stated in the maintenance section. Consider a replacement regulator that puts out more voltage and can tolerate a higher amp load. Heat is the main killer of solid state voltage regulators. Consider placing heat tape or similar on the regulator to determine its maximum temperature after landing. In flight, there should be sufficient air flow to keep the cowl temps reasonable. On a hot summer day, on a quick fuel stop, open the cowl doors and try to vent the cowl heat while fueling.

*Note: After engine start, a great deal of stress is placed on the Ducati if the full load of the buss is put on the system shortly after start while at idle. Technique: After engine start, prior to turning on the high amp items such as the COM/NAV/Landing lights, iPads, incandescent lights and strobes, Pitot Heat, etc. allow the alternator to charge the battery a bit. On an ammeter one can see immediately after starting the battery is pulling 3-10 amps (depending on battery charge state). Within 10-15 seconds, the ammeter will decline to about 1-2 amps. Once the amps drop to this level, turn on avionics systems. Ammeters should be installed to show the amps going to the battery rather than a load meter (which is the ammeter going to the main bus only) for the best method of determining your charge state. The prop blast will also rid the engine compartment of heat if starting after a quick fuel stop. A high amp load on a heat soaked regulator will greatly shorten its life.*

I must mention again, if your charging is weak and you have a gearbox PTO driven alternator attached to your engine gearbox as the main alternator, these PTO driven alternators do not put out enough power from idle to 4000 to meet the needs of most aircraft systems on the ground. If you have two alternators, use the Rotax internal alternator for the main bus and use the PTO driven alternator to power a separate bus for exterior lights, pitot heat and other high amp devices not necessary for flight. Consider a split buss with a bus tie to allow linking the busses in the event of alternator failure.

**TAKEOFF:**

**Most engine problems manifest themselves during the takeoff phase. Rarely do problems occur in flight.**

**914 Engine Boost Way Below Normal. Engine is smooth running.**

**Check your airbox is attached and hasn't slipped off, then:**

a. Fuel pressure is normal: The servo controller is not closing the waste gate, or the servo cable has slipped. With the engine off, investigate by observing the waste gate arm and watch it cycle when the TCU is turned on. If it looks good, see below. If it has little movement, move the throttle and watch it open and close. If the cable slipped, readjust

the cable per spec. Check the servo controller. Check the throttle position sensor and clean the contacts.

b. Turbo controller temperature input inoperative. The temp probe may be showing too high of an airbox temperature, and the TCU (Turbo Control Unit) will open the waste gate reducing boost and lowering power output. Clean the temp probe contacts. Ohm out the probe if suspect and or replace the temp probe. You may see a Turbo Caution or Warning light. Do not fly with a TCU warning light. Reduce power to maintain engine limits and land and investigate.

c. Once back at the hangar, check your float bowl vent tubes and plumbing are sound. Leaks in the tubes at the plenum pressure pickup barbs will cause many issues.

**If the engine is not running smooth, surges, or cuts out and catches and is sounding like it is lean or running rough above 30-35 inches or 5500 RPM:**

a. Fuel pressure low: Fuel pressure regulator failed or is failing. The turbo boost will max out at 5 psi or about 40 inches of MP on takeoff. A rough correlation between boost and MP is: for every one psi of boost you should see two inches Hg of MP increase. (Mathematically: 29.92 inches of mercury is equivalent to 14.7 PSI to which means roughly speaking a 2:1 ratio.) For every pound of boost pressure over atmospheric, the fuel pump pressure must be increased to the carb by one psi also.

**Example:** Altimeter reads 30.00, and at idle fuel pressure is 5 PSI. On run up for takeoff, at 34 inches of manifold pressure, the airbox boost pressure will be roughly 2 PSI as will the fuel pressure be at least 2 PSI higher than static or about 7 PSI, and at 38-40 inches of manifold pressure the airbox and fuel pressure boost will be 9-10 PSI or higher.

*Note: Fuel pressure increases as boost pressure increases to prevent the carbs from leaning out. It is true that the plenum pressure will force the fuel from the float bowls, starving the carbs of fuel under high boost conditions. The Rotax manual states that a differential between boost pressure and fuel pump pressure must be maintained at approximately 2.5 to 5.8 psi. UMA produces a gauge to read this differential, however, if the fuel pressure regulator has failed, and the fuel pump is working fine at 5 PSI, the carbs will begin to empty of fuel and the engine will very soon sag and run very rough or even die. The pilot will not see the fuel pressure problem because this differential gauge only reads the difference between airbox and fuel pressure. Since the airbox pressure is low due to poor power (boost low), the fuel pressure will stay in its range although the carbs are starving of fuel. The reason for roughness is, the float bowl slightly higher over fuel pressure causes leaning, the engine RPM will decrease the turbo boost pressure below normal due to lack of exhaust flow with the throttle wide open. This is confused by many as low boost and rough running only when it can be a fuel pressure problem.*

Example of how to use a standard fuel pressure gauge during operations and troubleshooting in the field: On a direct reading fuel pressure gauge attached aft or on the side of the fuel pressure regulator (typically a banjo nipple added on to the output side of the pressure regulator) the fuel pressure static at idle or off is about 5 psi at zero boost (2.5 to 5.8 required)... On takeoff, the max continuous power setting will yield 34-35

inches of MP (35 less 30 atmospheric is 5 inches Hg and your boost pressure is found by taking half of that which yields approximately 2.5 psi of boost pressure). The fuel pressure must rise this amount (2.5 psi) to give the equivalent of 5 psi at the bowl to maintain proper flow rate and atomization. Therefore, your fuel pressure will rise to be about 7.5 psi. At Takeoff power, (40 inches Hg), your fuel pressure can be as high as 9.5 to just shy of 11psi at sea level and higher at higher pressure altitudes. If you have the UMA differential gauge, the fuel pressure, less the airbox boost pressure will always indicate 3-5 PSI or less fuel pressure differential if all is working well. If the boost side of the pressure regulator fails, the fuel pressure will still read 5 psi on the UMA gauge because the regulator only reads the pressure differential. As stated above, the airbox pressure will be lower due to a carb issue (leaning) and turbo output so the pressure differential will stay roughly unchanged. This makes troubleshooting a little more difficult. If you have a differential pressure gauge only, simply remove the airbox pressure hose tee'd in between the pressure regulator and airbox and plug the airbox pressure line to the differential pressure sender. This makes the UMA differential gauge a direct reading gauge. Note that your EIS warning sensors will indicate an over pressure possibly.

**On Takeoff, fuel pressure is rising as desired and above 34-35 inches and full throttle (past the 100% stop) and the engine seems to be cutting out, surging, or dying of fuel starvation. (I.e. running snarly.)**

With the fuel pressure good, it is the high pressure tap or solenoid valve that is most likely clogged or not working properly. (See the section on the 914 plenum leaks and the solenoid troubleshooting above.) Do not takeoff if full turbo is needed. If airborne, reduce power to maintain the engine power and limits and land and investigate as soon as practical.

**On Takeoff, the engine runs smoothly but begins to sag or power output is low after running at full power for 30 seconds to a few minutes.**

a. Fuel pressure low: See above. Switch tanks and filters via the fuel selector and turn on the auxiliary boost pump immediately! If fuel pressure returns to normal and the engine runs fine, land and investigate. It could be a pump has failed, filter is clogged, the vent blocked, or there are fuel pressure regulator problems so read below:

b. If the Fuel Pressure is slightly low and increases marginally by turning on the Aux Pump. This could be a vent problem. Turn on the Aux Boost pump, switch tanks, and reduce power to maintain aircraft control and flight speed. Return to base and or land as soon as possible. Check your fuel vent for blockage. You may have left the vent cover on or a foreign object is clogging the vent. If the fuel tank vent becomes blocked, the fuel will feed to a point where the unvented tank will form a suction and restrict fuel flow to unacceptable levels and even completely starve the engine. Again, if the vent is not fully blocked, the additional fuel suction of both fuel pumps running may assist the venting issue or exacerbate it, reduce power, and land immediately and investigate. Vent tube design is critical. Some manufacturers require one or two small holes in the bend in the vent tube near the wing/fuselage entry to assure a foreign object impacting the forward facing vent does not prevent vent operation. Check your vent is clear after

muddy field ops, extended down time without a cover (mud dobber or wasp nest) and during every oil change!

c. Airbox may have loosened but not slipped off. This is noted by low MP (no more than 26-30 inches or normal atmospheric pressure) and only 80 HP is available because without the pressurized airbox, the 914 becomes a 912 with funky carbs. It will run OK, just provide a lot less power. Land as soon as possible and investigate as debris may enter your carb.

*Warning: With a constant speed or cruise prop the loss of pressure in the airbox may reduce the power to the point the propeller will be turning at a very low RPM (about 4000) making takeoff impracticable or impossible. Abort the takeoff if the engine is not performing properly and investigate.*

**914 Warning lights flashing or 912/914 engine RPM fluctuates or surges.**

914: TCU/Servo hang-up. The TCU is hunting and will cycle the servo to open and close the waste gate. This is caused normally by a poor temp or pressure sensor input causing the TCU to reduce power to prevent the perceived overtemp. The airbox pressure sender may sense an over pressure condition but the slow turning servo control of the waste gate gets out of sync with the TCU computer correcting the over pressure/temperature sensor condition. During takeoff, simply stop the servo with the reset switch and hold it for a second, then release. Reduce the throttle to max continuous or lower to keep MP in check if it continues to cycle. It normally ceases cycling or surging at reduced power (max continuous) and the flight may be continued. Refer to the Pilots operating manual for the Rotax 914. A 912/912S surging with a fixed pitch prop is normally a carburetor fuel leak or exhaust leak impinging on a carb float bowl.

*Note: If a constant speed propeller is installed, a failing propeller controller or speed sensor will cause the prop to fail to hold its governed RPM and the RPM may fluctuate or hunt by over 100 RPM. Go to MANUAL control on an Airmaster constant speed propeller to check if it is the TCU or prop controller. If you have a hydraulic propeller, reduce the throttle to get stable operation and land immediately as you may have an oil leak if it is the hydraulic propeller controller or system.*

*Note: If you have a belt driven alternator, and an electric constant speed prop, the alternator may have a field coil failing. The field coil failure causes electromagnetic interference affecting the electric sensors on the propeller Hall Effect sensor (RPM counter) and even the engine sensors. Turn off the offending alternator and check operation. If that cures the propeller hunting, and engine sensors, get the alternator completely rebuilt, and consider a Mu shield.*

**912 or 912S engine sags at full power only:**

Typically, if a normally aspirated engine sags it is fuel related.

a. The carbs may be impacted by an exhaust jet from a leaky muffler pipe to head or pipe to muffler fitting, or a cracked or broken exhaust pipe heating one carb and causing the carb to boil off fuel. Look for brown soot stains on the exhaust pipes and head to exhaust pipe attachment. An exhaust leak is typically seen at high power settings as a rough running engine just prior to the sag due to fuel starvation. Heat damage can destroy the

carburetor. Reduce power and abort or land and inspect the exhaust for soot and find the leak. Then engine will normally run at a reduced power setting but land as soon as possible and investigate.

b. Fuel pump failure: Fuel pressure is a must, even on a 912. Your fuel pump may show signs of leakage. Replace it if leaking. If the Aux Boost Pump is ON during takeoff this problem should not occur until the aux boost pump is turned off. If the fuel pressure is low or drops, turn on the auxiliary boost pump, land and investigate.

*Note:*

*Fuel pressure readings fluctuate when turning the Aux Boost Pump on and off. This is due to the change in pressure and flow. It is not uncommon to see a 3PSI drop when using the FS02 as the restrictor in a 912S at climb power. It is normally caused by gauge smoothing and not a fuel pressure loss. It is an indication problem. When at cruise power or descending into the pattern, turning on or off of the aux pump only causes a mere dip in pressure.*

**Warning:**

***If the engine behaves as if it is fuel starved, a fuel leak may be the problem. If fuel smell is observed, reduce power and land as soon as possible!***

c. Fuel tank vent blocked. See above.

d. Fuel filters dirty or fuel line clogged. See above.

e. The 912 series have an orifice (FS02 or carb jet) to control the pressure range of the 912 instead of a pressure regulator. If this small orifice is in a fuel line and becomes dislodged or become clogged it may allow complete fuel bypass through the return line and low pressure at the carbs or if clogged manifest itself as excessive pressure and flooding. Investigate thoroughly as a dislodged orifice allows insufficient pressure to meet the full power needs, or if clogged it will cause flooding and increased flow and overpressure which will result in flooding of the carbs and a possible engine roughness or fire hazard.

f. Fuel pressure sender failure: I never fly with a failed pressure sender on the 914. Some fuel pressure senders do not work well when used on the Rotax 912 series as the pressures are somewhat low for many senders to be accurate (3-6 PSI for the 912). Use a fuel sender from a reputable vendor for the aircraft fuel system and test the sender's accuracy with a mechanical gauge.

**High CHT at Maximum Continuous or Climb Power Setting:**

On an existing factory-built aircraft, a sudden cooling problem must be checked immediately. On a new aircraft or homebuilt, this is typically a problem with inadequate radiator ducting, failure of the radiator cap to maintain pressure (or is loose), coolant leaks or too slow of a climb out airspeed for proper airflow through the radiators. The experimental builder should have solved cooling issues during the flight test phase. However, some manufacturers and experimenters allow an aircraft to go operational

without proper cooling system performance. In the event of high CHT reduce power and or increase airspeed land and investigate.

a. Land and check coolant hoses, cap and ducting for clogging debris and leaks. Repair lines, leaks and check the cap is seated and functioning properly. Make sure the ducts are clear and tight. A blown-out cowl seal around a radiator can be repaired with tape sometimes for a quick fix during testing.

b. Many aircraft cannot cool properly due to poor cowl design. Lower the climb rate and reduce power. Once the CHT is below 250F, advance power and maintain at least 90KIAS and watch the CHT. If the CHT quickly climbs again, land and check for symptoms below:

c. IF the EGT is about 14-1500 at 5500 RPM at full throttle, that is OK, but if higher, check for an intake manifold leak or consider re-jetting the carbs, as the engine is running a too lean.

d. IF the oil temperature is high also, it is poor ducting and cowl design or failure to duct the coolers properly.

e. IF the coolant shows no sign of overflow, check that your CHT gauge reads properly. If monitoring CHT #2 as well as #3 compare the two. A bad ground or wire can significantly change your CHT reading. Calibrate your CHT probe and protect the probe area from excessive reflective heat from the oil tank and exhaust pipe. Consider adding a plenum to the finned cylinders for better air flow over the back of #3 cylinder as it helps.

f. If only the coolant temperature probe (recommended by Rotax in the 1 inch exit hose to cooler) is reading high, compare to the cylinder head temperature. The coolant temperature probes commonly lose their ground and peg out frequently. Monitor your CHT and land as soon as conditions permit.

f. For those having continuous cooling issues, follow the improvements in Cooling 101 (New version released in April 2020) on my website religiously and even on 100F days, one should be able to taxi for 20-25 minutes then takeoff and climb at 90KIAS to at least 10,000 MSL without exceeding 245F on the CHT.

## **IN FLIGHT and LANDING:**

Once the engine is stable at cruise, few problems occur. Monitor the oil pressure, temperature and fuel. Some common inflight problems are:

### **a. Engine slowly losing power.**

Slowly lowering fuel pressure is probably bad/dirty gas at the last stop and the main fuel filter is clogging. Turn on the auxiliary boost pump and switch to the reserve or other tank. If it clears and each tank has a its own filter it is the filter most likely. Land as soon as possible at the nearest field and investigate.

*Note: Always carry a spare filter. Especially if using auto fuel or flying out of farm strips or similar fields which pump gas rarely. The replaceable filter element type of fuel filter must be assembled correctly as it tends to loosen up a bit after a few hours when first installed and leak. Again, pay attention. After any servicing, recheck your fittings and after a test flight pull the covers and check again before proceeding on. Those using gascolators must not count on all debris in the fuel being heavier than the fuel and not clogging the screen. I do not use gascolators. The Europa uses dual fuel filters and since I use good fuel in our no sweating plastic tank, I've never had a water issue and only once did I have dirty fuel.*

Fuel pumps do fail and or leak in flight. A smell of fuel or loss of pressure is a symptom that should not be overlooked. Turn on the aux boost pump, land and investigate. Piersburg pumps do fail mechanically or structurally. I had a very old 914 Piersburg pump go out due to ethanol destroying the internal seals. I have also found on inspection the outlet plastic fitting on an older Piersburg pump used for the aux pump cracked and leaking while under pressure spraying fuel in the cockpit. The new Piersburg pumps operate fine with up to 10% ethanol.

The mechanical pump on the 912/912S engine was changed in 2014 to a new larger style that may affect cowl clearances as I have seen a few pumps in which cowl screws or fasteners rubbed a significant cut in the fuel pump housing. Pay attention. This new pump has a drain line as stated above to warn of a diaphragm leaking. Use clear tube on this drip line if possible to monitor if the diaphragm is leaking. Place the drip line in a neutral pressure area in the cowl, to prevent low cowl discharge pressure from reducing the fuel pump diaphragm pressure as it affects pump operation.

#### **b. Carburetor Icing:**

The Bing carburetor rarely ices up but it can in typical carb icing conditions. Apply carburetor heat. Move the throttle up and down to clear the throttle plate of ice. Climb or descend to avoid carb ice conditions. Why doesn't carb ice occur in motorcycles with the Bing carburetor? It is because the throttle is never steady for long periods at wide or near wide open throttle. If equipped with the aftermarket coolant heater on the manifold side of the carb, the carb stays hot enough so it shouldn't ice up if left on continuously. Getting enough heat fast enough may be a concern if you installed an on/off carb heat control valve on the water heated type carb installation, the tubes to these carb heating tubes are relatively small and warming takes a while. If you don't have carb heat installed, simply move the throttle fore and aft to break the ice from the throttle plate, piston and needle and it hopefully clears quickly if caught early on. Either way, if the ice clears, the engine will run rough for a moment until the ice is gone and the prudent pilot will look for a forced landing site until full engine performance is attained and avoid carb icing conditions. Failure to install a carb heat system is poor design for the operation of a normally aspirated engine using a carburetor. The 914 turbo does not require carb heat due to the hot turbo air charge, nor does a fuel injected engine normally as the fuel atomization spray is well down the intake just above the intake to head connection.

#### **Fluctuating oil pressure or temperature readings:**

This is almost always the senders or electrical interference. Land at the nearest suitable airfield and investigate.



a. A sticky pressure bypass spring in the pump can cause rapid cyclical fluctuations of the oil pressure. Land as soon as possible and investigate. To be safe, check with a direct reading gauge, clean or change the ball or plunger with the updated version and clean the cavity on the oil pump. If the oscillation is slow you will troubleshoot days, change the plunger or ball in the oil pump pressure regulator but normally it is not a mechanical problem. Replace the sender or check with a direct reading gauge. It is not uncommon to have a bad oil pressure sensor, affect the oil temp sensor because of a short in the oil sensor affecting the peaceful ground or wiring of the nearby oil temp probe.

b. If you have a belt driven alternator, turn it off and check your temp and pressures. If all your readings smooth out, the alternator needs to be replaced or a full rebuild as the field is flooding your engine compartment with electromagnetic noise or 12volts is shorting into your engine case disrupting the ground plane of the nearby senders. Continue your flight on the Rotax alternator avoiding high amp draw operations. Cut your amp load as appropriate. In the event of a potential bad alternator you will need to find a true rebuilder of alternators. If you take it to the auto parts store for a test, it will test good as the regulator in the alternator is producing the voltage, however, you have a bad field winding or short which is more than likely causing the problem and your basic auto parts store checker won't find that. An alternator rebuilder checks the windings as well as the regulator.

c. High Water Coolant Temperature: Many folks have installed water temperature probes in their radiator cooling lines to monitor coolant temp. These are notoriously inaccurate because of their grounds. If the water temp is sky high, and the cylinder head temps normal, disconnect the water temp sensor and press on. I monitor the cylinder head temps only. The GRT resistive temp probe is very sensitive to the ground of the sender and unit. Make sure the grounds are sound if using resistive temp probes.

d. Encountering rain in flight, the oil pressure begins to drop, and the oil and CHT temps rise. Don't do anything initially. Fly out of the rain and investigate. If the readings return to normal, avoid flying through rain or land and investigate. Builders and installers will often put an exposed terminal block or their entire engine monitor on the firewall or foot well with some or all the sensor wires connected there completely exposed. Some engine monitors attach to the firewall and all the wires are exposed to the elements in the cowl. If the terminals get wet or are covered with dust and grime, the rain will activate the crud on the terminals and one can expect very unusual engine readings due to current leakage. On landing, either waterproof the terminal or protect it from rain. I don't use this type of terminal nor do I mount exposed engine monitor terminals to the elements in the engine compartment. These types of connection are prone to collecting engine dirt, and shorting or leaking voltages to ground, which affects engine instrumentation.

### **High CHT at Cruise Power:**

This is usually the first indication of a coolant leak. A broken exhaust pipe, a failed or loose radiator cap or hose leak will begin to show on the CHT first. This occurs normally during the climb out. As the CHT climbs, look for an airfield and land as soon as possible. The engine can run for about 30 minutes before the engine fails with no coolant. At low power it lasts longer. Avoid getting all tensed up, land at the nearest

strip and investigate but stay reasonably high and prepare for a planned forced landing in a safe area.

**Low or no oil pressure:**

a. Normally the engine will fail with zero oil pressure in only a few minutes. (Typically, it is the first sign of a problem.) A loss of oil and pressure will normally be accompanied by high oil temperature but not always. In any case, maintain altitude for a safe gliding distance as long as you can, and when the engine seizes, feather the prop if equipped and look for any field or safe spot to land.

Many times, low pressure is a symptom of a sender failing. As long as there is an indication of oil pressure and the temperature looks OK, land as soon as possible at the nearest airport and investigate. Stay reasonably high to allow sufficient time to glide to a safe forced landing spot in a non-populated area or airfield just in case. Oil pressure senders that short internally go to zero, but a partial failure will go to a very low pressure indication.

**Engine Roughness:**

If the engine begins to suddenly miss or run rough, head for the nearest field.

Immediately switch tanks and turn on the auxiliary boost pump.

If equipped, turn on the carb heat.

Move the throttle up and back to clear any ice in the 912/912S carbs.

a. Check the ignitions. Go from BOTH to A then B and see if the roughness has improved.

b. Check fuel pressure is in the normal range.

c. Check for unusual fuel or electrical smells.

d. If you have recently gone through rain when the roughness started, and it is associated with a different noise (like a buzz saw) the propeller may have shed some paint, leading edge tape, or a blade tip has a crack. A propeller spinner/backplate fatigue failure can cause significant vibration, sometimes confused with engine roughness. Maintain the minimum RPM necessary and proceed to land at the nearest airfield available and investigate.

e. Sometimes we see rough running after a long cruise at low power, or during a long low power descent. This is normally the feeling of a miss or thump from the engine. This is indicative of the plugs fouling a bit. Run the engine up to 5000 or 5500 to clear the plugs approaching level off. Technique, if you have a constant speed prop, simply move the prop to a fine pitch and add a small amount of power and it will clear this quickly.

f. Approaching the field, during a high-speed descent, pilots complain of vibration or gearbox clatter at low power settings. With the propeller in a course pitch and the power very far back, the propeller can be on the verge of wind milling the engine causing the gears in the gearbox to unload a bit. By this I mean if the power setting is just high enough to cause the prop to pull, and the airspeed sufficient to windmill, the gearbox lash may be heard and felt as a vibration. Simply push the power up or down out of this range. This is a common complaint on ground adjustable propellers set for cruise flight as

well as constant speed props in fine setting while in a descent. This gear lash is noted in the operations manual.

**Some other common vibration or roughness:**

**Airframe Roughness:**

1. Loose or broken engine mount.
2. Control flutter on a slow airplane. (Fast aircraft (over 120 KIAS normally) just flutter and suddenly tear apart.)
3. Loose wheel pant or fairing.

**Propeller Roughness:**

1. Spinner not aligned after maintenance.
2. Balance weight loose or departs.

***Warning:***

***Never put a balance weight directly on a spinner! Typically this will fatigue and destroy the spinner and backplate. Put the balance weight in the holes provided, OR MAKE ONE, on the backplate.***

3. Prop not balanced. Newly installed props must be statically and dynamically balanced. Propellers can go out of balance or pitch due to damage, loss of paint due to rain, damage from ground objects being kicked up etc.
4. Excessively long prop extension. (These extensions can vibrate loose or deform. Extensions of 4 inches are my maximum length personally.
5. Prop too close to the cowl (especially a two blade). As the blade passes a flat cowl face, the pressure wave of the prop is transferred to the cowl then the airframe. Additionally, the blade lift/thrust is momentarily interrupted affecting smoothness of the engine/prop rotation. Example: The two blade Sensenich or Whirlwind on a 914 is quite noisy in comparison to the three blade equivalent and a vibration can be felt as the blade pulse passes the windscreen. This small but noticeable pulse can be annoying and felt in the human body.

**Fuel smell in the cockpit may or may not be accompanied by fuel pressure or flow fluctuations:**

In experimental and LSA aircraft every fuel system is different, tank locations vary, fuel lines and routing vary, and it is difficult to have a set reaction to a proper course of action. Recreational or rental fliers of LSA aircraft usually have no idea of the fuel system design.

In general, if a fuel leak is evident by a strong fuel smell, attempt the following:

1. Maintain a reasonably level flight attitude.
2. Vent the cockpit. (Open the door, crack the canopy if cockpit vents are poor.)
3. Attempt to locate the fuel leak if lines run through the cockpit.
4. Avoid radio transmissions or especially the turning on and off switches or make radio communications until the fuel leak is found/stopped or you run out of fuel.

Hopefully every fuel component is in a tray or has a fuel drain to safely vent the fuel overboard, and especially hopeful the cockpit seating area of the cockpit will not allow fuel to puddle in/near electrical components or passengers/crew.

If fuel is leaking between the fuel shutoff and fuel tank there is little you can do but wait it out and hopefully get in a radio call if the fumes are vented clear of the cockpit, then land at a suitable airfield using an auxiliary tank if equipped. Fuel filter miss assembled or quick disconnect O rings are cut or missing are a common leak source prior to the fuel shutoff as are the fuel line attachment at the tank or sight tube. Hopefully, the fuel will drain from that tank or tank side and you will be able to use the other tank and land. Did you remember to build in fuel drains in the belly of your plane? Under the seats or center tunnel, and fuel tank area.

If the fuel is leaking between the fuel shutoff and engine, fly until over a suitable forced landing spot or airfield and shut off the fuel valve. Fuel pumps are normally in the cockpit area and if fuel is spraying or dripping on your feet from the firewall, take action immediately. Shut off the fuel valve or transfer pump if possible, without causing a spark. Obviously, the engine will stop, and so should the fuel leak hopefully. If the cockpit is clear of fuel vapor and smell, radio your intentions and plan an engine out pattern into the intended landing spot/field.

Today's solid-state intercom and radios have little chance of creating a spark sufficient to ignite a well vented cockpit and intercoms should not spark provided you don't plug and unplug the headsets. Speakers can arc but rarely do. Master contactors do spark and are vented to the atmosphere so relays and high amp contactors should not be activated when there is a significant fuel leak and fumes.

*In conclusion, these are my troubleshooting experiences I've had over the last 50 years civil and military flying and 20 years of flying and maintaining the Rotax. Although long winded, it is not comprehensive but a guide to start from. Please feel free to download this file and save on your electronic viewing device for reference at the field to help in your building and or troubleshooting your older/carbureted Rotax engine. I keep a file (as well as all the aircraft and systems manuals, electrical pin outs, maintenance and operating manuals) on my phone for cross country reference as even I forget some of the symptoms and possible solutions. I just wish this paper was shorter for you all, but then I get criticized for not giving sufficient explanation.*

*Bud Yerly is owner of Custom Flight Creations, Inc. He is a retired USAF military fighter pilot, instructor, evaluator, IG, trained accident investigator, aeronautical engineer and has years of functional test flying experience. He was the US Europa Dealer for many years as well as a technical advisor for the factory. He is currently a still a US dealer for Airmaster Propellers. He is active in the EAA and is an EAA Technical Counsellor. He has assisted in the building and test flying of many experimental aircraft powered by many different engine types. He currently owns and operates Custom Flight Creations, Inc. and personally owns a 914-equipped Europa Kit Aircraft with 500 hours in all types of Europa aircraft. See his website for more techniques and information by typing in your web browser <https://www.customflightcreations.com> and you will find although Google search puts it buried deeply in its search results.*

## Index

Topic	Page	Topic	Page
<b>A</b>			
Airbox	18,41-43	Jump Start	39
Alternator	6-9,41,46	Jerry Cans	34
Auto Fuel	16,34-35,45	<b>K</b>	
Aux Alternator	7,9	<b>L</b>	
Aux Boost Pump	7,43,47,47	<b>M</b>	
AvGas	10,11,13	Maintenance	
<b>B</b>			
Battery	2,3,6,7,11,39-41	Maintenance Stator	3,5,6,27
Belt Driven Alternator	8,9,43	Maintenance Turbo	9,10,11,12,13
<b>C</b>			
Carburetor Balance	10,11,15	Mag (Ignition Module)	3,11,14
Carburetor Float Bowl	11,13,17-22,35,41,42	Manifold, Intake	17,19,21
Carburetor Icing	51	<b>Mechanical</b>	
Carburetor Leaking	19-21	Troubleshooting	2,14,15-17,23,24,26
Carburetor Synchronization	14,16	Carb Synchronization	15
Case Fretting	26,29,30	<b>N</b>	
Charging	5,6,9,39,40,41	<b>O</b>	
Checklist	10,11	<b>Oil</b>	
Choke	21,37,38,40	Leaks	27,28,32-35,47
Compression check	5,17,20,21,24,25,30-32	Pressure	11,32,36,40,46,47
Coolant Leaks	27,28,32-35,47	Pump	10,26,30,40,
Coolant Types	33	Tank	10,11,27
Coils	4,5,6	Temperature	11,44
Crankcase	1,10,11,25,30,39	Types of Motor oil	35
<b>D</b>			
Drip Tray	17,22	<b>P</b>	
<b>E</b>			
Engine Roughness	5,14,18,22,23,30,40,44,47	Plugs	4,5,10,11,17,34,39,40,47
Exhaust Leaks	31	PTO	7,8,29,30,36,41,45,48
Exhaust Springs	31,32	<b>Q</b>	
Exhaust Maintenance	32	<b>R</b>	
<b>F</b>			
Fretting	29,30	Radiator	11,28,33,44
Fuel Concerns	34	Radiator Cap	44
Fuel Filter	22,40,44,45,48	Regulator (See Fuel Pressure)	
Fuel Fluctuation		Restrictor Fuel	23,24
Fuel Pressure Regulator	18,22,-24,42,-43,45,47,48	<b>S</b>	
Fuel Types (See Gasoline)	34,35	Servo	12,13,41,43
<b>G</b>			
Gasoline	5,10,21,25,34,35	Stator	6,27,28
Gas Aviation or AVGas	5-16-34,35	Solenoid Turbo	11,18,19,39,42
Gas Automotive MoGas	5,25,34,35	<b>T</b>	
Gas Ethanol Auto Gas	21,34,35,40,45	TCU Servo	9,18,41,43
Gasket Carburetor	11,13,20,21,26,27	TCU Wastegate	11-13,41
Generator (See Alternator)		Throttle	36,37
Gearbox	7,8,14,23,28,29,34,35,41,47	Turbo Controller	1,18,41
Grounds/Ignition grnds	4,5,6,11,28,32,45,46,48	Turbo Waste Gate	11-13,21,41-43
<b>H</b>			
Heads	11,12,17,22,26-28,30-33,46	<b>U</b>	
<b>I</b>			
Ignition		<b>V</b>	
Ignition Module	3,4,5,11,14,40,47	Vent, Fuel	43,44,
Ignition Coils	4,5,6	<b>W</b>	
<b>J</b>			
<b>K</b>			
<b>L</b>			
<b>M</b>			
<b>Maintenance</b>			
<b>Maintenance Stator</b>			
<b>Maintenance Turbo</b>			
<b>Mag (Ignition Module)</b>			
<b>Manifold, Intake</b>			
<b>Mechanical</b>			
<b>Troubleshooting</b>			
<b>Carb Synchronization</b>			
<b>N</b>			
<b>O</b>			
<b>Oil</b>			
<b>Leaks</b>			
<b>Pressure</b>			
<b>Pump</b>			
<b>Tank</b>			
<b>Temperature</b>			
<b>Types of Motor oil</b>			
<b>P</b>			
<b>Plugs</b>			
<b>PTO</b>			
<b>Q</b>			
<b>R</b>			
<b>Radiator</b>			
<b>Radiator Cap</b>			
<b>Regulator (See Fuel Pressure)</b>			
<b>Restrictor Fuel</b>			
<b>S</b>			
<b>Servo</b>			
<b>Stator</b>			
<b>Solenoid Turbo</b>			
<b>T</b>			
<b>TCU Servo</b>			
<b>TCU Wastegate</b>			
<b>Throttle</b>			
<b>Turbo Controller</b>			
<b>Turbo Waste Gate</b>			
<b>U</b>			
<b>V</b>			
<b>Vent, Fuel</b>			
<b>W</b>			
<b>Waste Gate</b>			
<b>Water Temperature</b>			
<b>X</b>			
<b>Y</b>			
<b>Z</b>			