

# A HIGH PERFORMANCE AIRBAND ANTENNA FOR YOUR ULTRALIGHT / LIGHTSPORT AIRCRAFT

by Dean A. Scott ©August 9, 2006 (revised January, 2011)

In this article I present a simple, easy to construct, and easy to mount “Inverted V” half-wave dipole antenna that will significantly increase your range and clarity of communication in the aircraft radio band when compared to rubber-ducky and external commercial or homemade quarter-wave “whip” antennas.

Basic RF (radio frequency) and antenna theory will be discussed to explain some of the reasons for the design. For instance, what is meant by “half-wave” and “quarter-wave?” These terms refer to the length of a metal conductor or wire that resonates at a given frequency in the radio spectrum. Namely, a full-wave antenna is one whose length is the same as the distance from one crest to another of a radio wave. A half-wave would be half that length (crest to trough) and a quarter-wave would be half that again. The length of a radio wave is determined by the equation  $c / f$ , where  $c$  is the speed of light in millions of feet per second and  $f$  is the radio frequency in megahertz (MHz).

Electro-magnetic energy, such as light and radio waves, travels 983,568,960 feet in one second. However, due to complex interactions with conductors, surrounding structures, the ground, and other wires connected to an antenna system, this speed is effectively reduced to 936 million feet per second. Therefore, the equation for a half wavelength in inches is  $(468 / \text{MHz}) * 12$ ". For a quarter wavelength it is  $(234 / \text{MHz}) * 12$ ".

Why half- and quarter-wave rather than full-wave? Size. At a frequency of 122.7 MHz (typically average or center-of-the-band for Unicom and GA coms), a full-wave antenna is 7 feet 7 1/2 inches long! Try fitting THAT on or in your plane! A half-wave is 45 3/4 inches long

and thus more manageable, while a quarter-wave is about 23 1/2 inches long.

“But, doesn’t more wire generate more signal?” Compared to an isotropic antenna (a mathematically perfect antenna that radiates in all directions equally), a full-wave has 3 dB (2 times) more gain, a half-wave, 2.15 dB (1.7 times), and a quarter-wave, 0.15 dB. So, yes, a full-wave antenna does give the most gain, but at the expense of size.

But, you have to understand that gain is nothing more than a redistribution of a reference radiation pattern such that a certain direction is favored more in receiving and transmitting a signal than another. It’s sort of like placing a mirror behind the sun; it apparently becomes twice as bright even though it is radiating the same amount of light. The other half of the light we don’t see is simply being reflected back to us.

Another question you may be asking is, “Why is your half-wave antenna better the rubber ducky or single element whip I already have?”

First, the rubber-ducky antenna supplied with handheld radios is an inefficient design based on the low-gain quarter-wave. It also lacks a ground plane required for ideal performance. The idea is to pack a quarter-wave wire (say around 23-inches long) into a 6-inch long coil. The reason they are supplied is because they are cheap to make, very robust (it’s a bendy spring), and very few people like to carry around a radio that has a 2 to 4 foot long rod sticking up out of it!

Second, your typical “whip” or quarter-wave antenna requires a ground plane to obtain optimal performance, something a tube and fabric ultralight or light-sport aircraft just really

doesn't have. What's a ground plane? It's a flat expanse of metal around 4 feet in diameter that does what the name implies... simulates earth ground. If not a sheet of metal, then at least 8 stiff wires, each around 23 inches long, radiating straight out from the base of the main, 23"-long vertical antenna.

There's just no good way to mount such a design on an ultralight or other plane for that matter, nor would it be good to fly with something so ungainly. Some may say that the main boom or keel tube is a good enough ground plane, but RF theory and antenna design says otherwise. An aluminum skinned plane is a different story. A quarter-wave on them works fairly well and there wouldn't be much gained by making the antenna presented here.

Third, a half-wave dipole does not require a ground plane and has 2 dB more gain than a whip or rubber ducky. It also doesn't present much of a challenge to mount it compared to a whip (without a ground plane) and is just as easy to make.

Fourth and most importantly, this antenna is designed to perfectly match the impedance of your radio and coax cable for the best possible transfer of RF energy to and from the radio. It is also designed to counteract the imbalance created when the electrically balanced antenna is connected to the electrically unbalanced coax cable.

Your next question might be, "Sounds plausible, but how well does it perform?"

Consider this: Can your handheld radio with a rubber-ducky antenna, spitting out not much more than 1 or 2 watts of power, be clearly **heard** 30 or more miles away? Can **you hear** someone else's rubber-ducky equipped handheld radio that far away? How about when using an external quarter-wave whip antenna?

Your answer is probably no or not very well.

Using the antenna design presented, here I will attest that I can hear such a radio and can be heard by the same from that far away and farther! So, let's get down to business.

## PART 1 ANTENNA ELEMENTS

Figure 1 shows the simple nature of this "Inverted V" half-wave dipole design. It's made of two stiff wires, 23 5/8 inches long, forming a 120 degree angle. When used on Unicom and air-to-air communication frequencies (122 – 123 MHz), the element lengths and angle result in a 50-ohm terminal impedance, a perfect match for 50-ohm RG-58 coax cable.

Such an even match between the antenna, cable, and radio means that all possible power can flow through the system. A mismatch of impedances means power is wasted in the form of heat by the generation of standing waves in the coax cable.

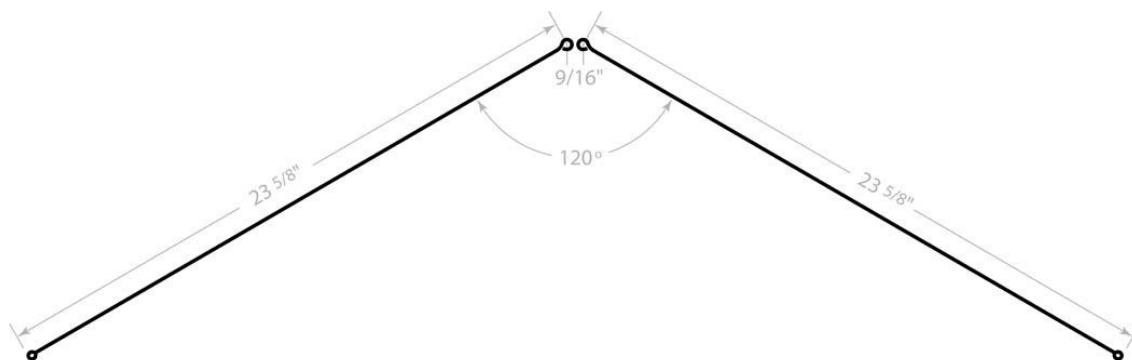

Figure 1 – Dimensions of the Inverted V antenna elements.

Anyway, any stiff wire 2mm in diameter (12 AWG) such as brass welding rods or even coat hangers can be used. Since coat hangers were on hand, that's what mine is made of.

### Step 1

Form the smallest possible loop you can on one end of each wire using stout needle-nose pliers.

### Step 2

Apply paste flux to this loop and fill it with regular electronics solder. This is more of an anti-eye-poker-outer than something the antenna design requires. Better to be poked with a blunt, rounded point than a sharp-edged skewer!

### Step 3

Measure from the end of the loop and place a mark at 23 5/8 inches and cut the rod 3/4 of an inch past that.

### Step 4

Starting at the mark, progressively bend the end into a larger loop with an inside diameter of a #10 machine screw (3/16"). Work slowly and incrementally to form a nice even and symmetrical loop. Cut the excess length off as you come around to the end of the loop. These are your antenna terminals.

### Step 5

Tape off the terminal loops and paint the antenna elements to protect from corrosion.

## PART 2

### FABRICATING THE MOUNTING BLOCK

We now need to devise a way to mount these two antenna elements so that they are held firmly in place at a 120 degree angle, while at the same time providing electrical isolation of the elements from other metallic parts of the system as well as allowing you to connect the terminals to your RG-58 coax antenna cable.

### Step 1

Obtain any sort of hard, dense plastic material that's 2 inches wide by 5 inches long by 3/8

inch thick or so. A good source for this would be a common kitchen cutting board. Draw a center line dividing the length of the block in half (Figure 2).

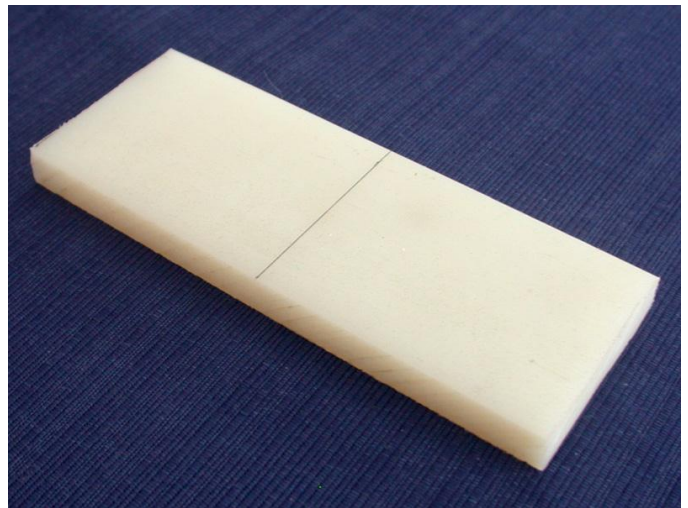

Figure 2 – Polypropylene or Nylon stock makes a good base for the antenna mounting block.

### Step 2

Draw a line perpendicular to this that is a 1/2 inch below the top edge. On this line mark the locations of the two antenna terminals, one on either side of center the line and 9/16 inch apart (Figure 3).

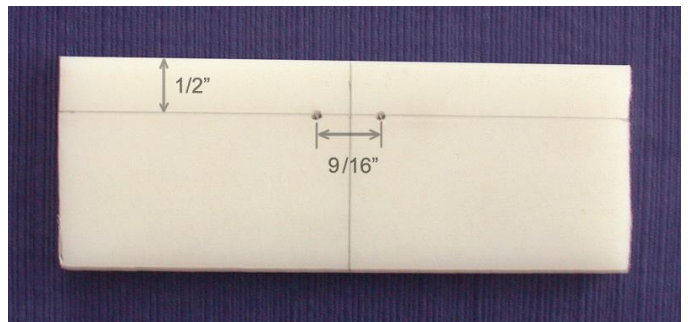

Figure 3 – Marking the antenna terminals.

### Step 3

With the center point of a small protractor positioned directly over each terminal hole, mark a point on the bottom edge of the block at the 30 degree point. Repeat for the other hole. Draw a line connecting each mark to its respective terminal hole to form a 120 degree angle. Draw a line a 1/2 inch up from the bottom of the block to mark the location for mounting a BNC connector (Figure 4).

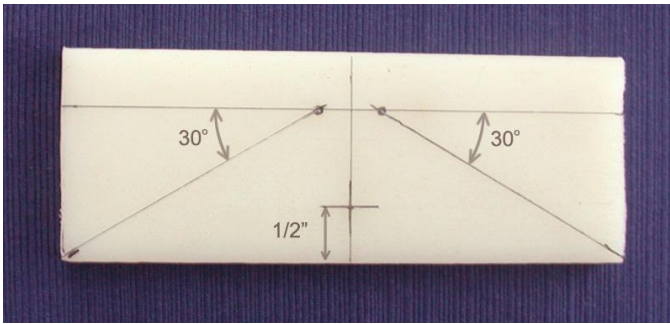

Figure 4 – Marking the 120 degree angle and BNC connector location.

#### Step 4

Drill these three locations with a 1/8 inch pilot hole. Countersink the antenna terminals with a 1/2 inch wood bit 1/8 inch deep (Figure 5).



Figure 5 – Countersinking the two antenna terminal holes with a 1/2" wood bit.

Countersink the BNC connector hole with an 11/16 inch wood bit 1/4 inch deep.

Drill the antenna terminal holes to size with a 3/16 inch bit and the BNC connector with a 3/8 inch bit (Figure 6).

#### Step 5

Using a table saw or other means, cut grooves along the 30 degree angle lines that are 1/8 inch wide and 1/8 inch deep (Figure 7).

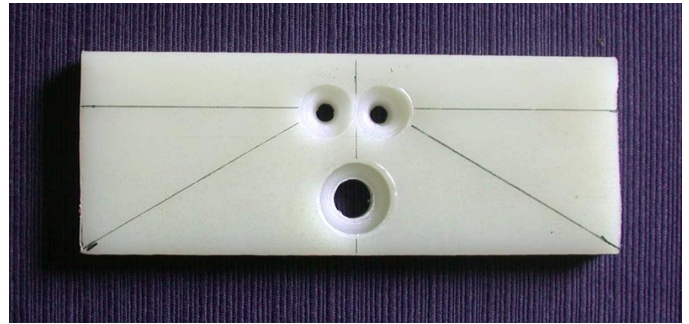

Figure 6 – All holes countersunk first and then drilled to size.

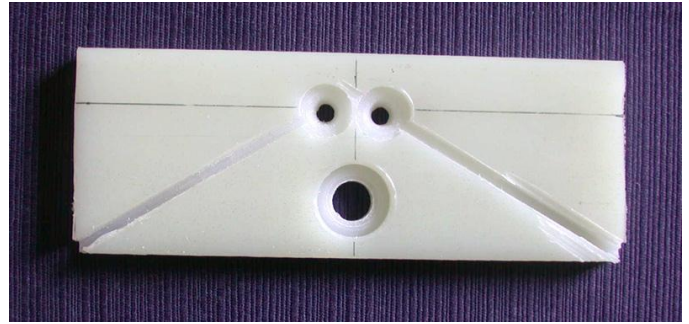

Figure 7 – Grooves for antenna elements cut into block.

### PART 3 ASSEMBLY

#### Step 1

Attach the antenna elements to the block with 3/4 inch long #10 machine screws. Place two flat washers onto the screw first, followed by an antenna element, then insert the screw into the block and secure with another flat washer, a lock washer, and a nut on the other side of the block (Figure 8).

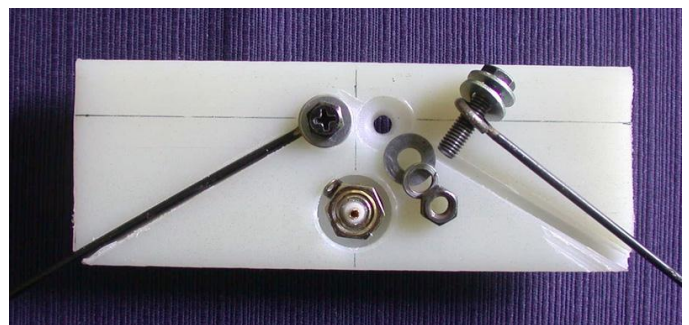

Figure 8 – Mounting the antenna elements and BNC connector.

#### Step 2

Place the BNC panel mount connector into the 3/8-inch hole from the back side so that the center terminal of the connector sticks up on the



countersunk side of the block. Tightly secure with the supplied solder tab washer and nut (Figure 8).

### Step 3

Cut lengths of stiff, solid copper wire such as can be obtained from the center conductor of regular TV coax cable (Figure 9).

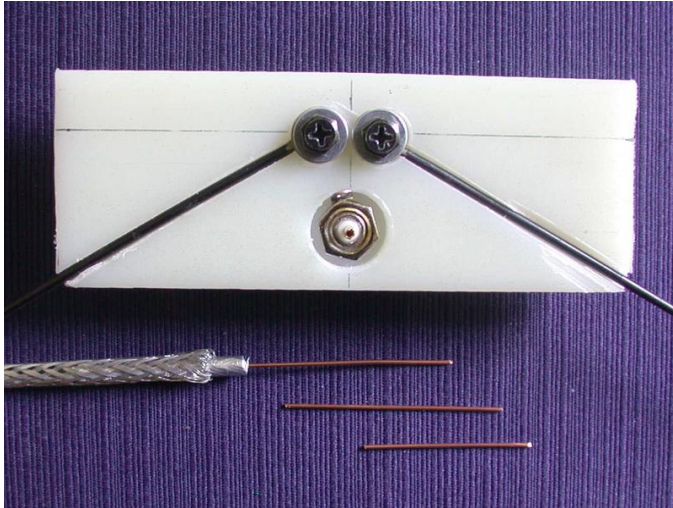

Figure 9 – A good source of stiff solid copper wire for antenna terminal connections is TV coax cable.

Make loops in the ends of each wire to fit the #10 machine screws and bend as needed to reach the terminals of the BNC connector (Figure 10).

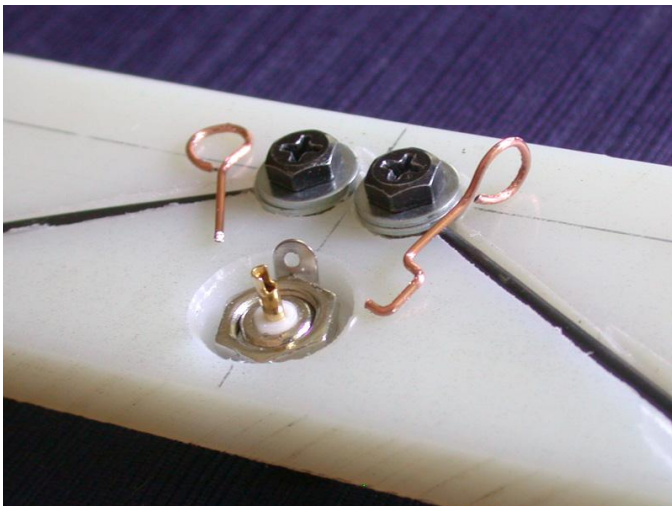

Figure 10 – Wires bent to connect the antenna terminals to the BNC connector.

Place each loop between the pair of washers of the antenna terminal screws and solder the other end to the BNC connector. The center

conductor goes to one antenna element and the ground goes to the other (Figure 11).

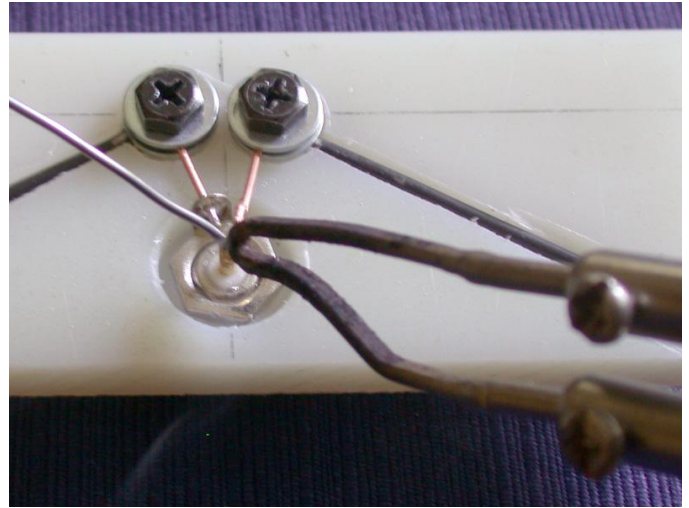

Figure 11 – Soldering the wires to the antenna terminals and BNC connector.

At this point most would consider the antenna finished and ready for mounting, but really it is not. Connecting a BNC jack to the antenna terminals like this creates an unbalanced electrical condition due to the unbalanced nature of the coax cable.

The reason why is too complex to deal with here, but suffice it to say, it has to do with the way RF current flows only on the surface of a conductor, not in it, and how current flowing on the outside of the center conductor induces an equal and opposite current on the INSIDE of the cable's braided shield. Since the cable is electrically unbalanced, current reflects back from the end of the grounded antenna element and flows down the cable on the OUTSIDE of the shield.

Yes, two different currents are flowing in different directions on different sides of the same shield. Electrons buzzing around at radio frequencies are very strange critters!

This reflected current diverts power away from the antenna elements, turning the cable itself into an antenna as well, one with unpredictable influences. We can prevent this reflected current from flowing back down the cable by installing a device called

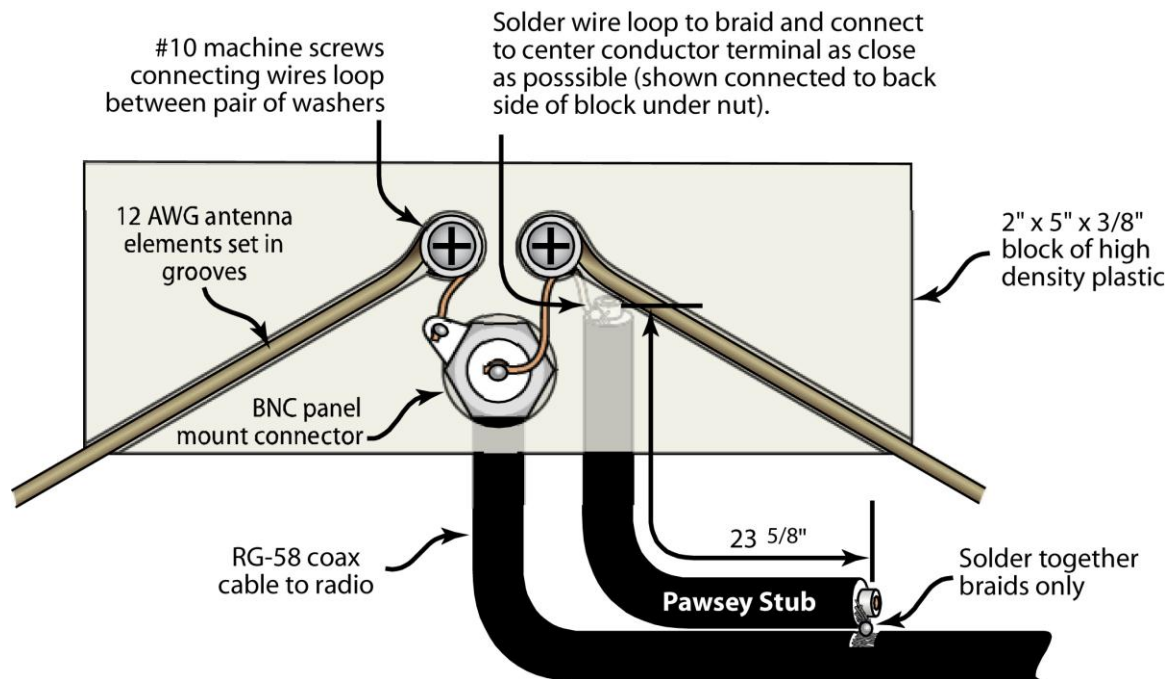

Figure 12 – Details of the electrical connections and the Pawsey Stub.

a balun (**balanced** to **unbalanced**) transformer.

There are a few different ways of making a balun. All do the same thing; transform an unbalanced RF current flow to a balanced flow. I use a variation of the Sleeve or Bazooka balun, called a Pawsey stub, due to the simplicity of construction.

As shown in Figure 12, the Pawsey stub is simply a quarter-wave length of RG-58 in which only its shield is connected at one end to the radio's coax shield, and at the other end to the antenna's center conductor terminal. The stub's center conductor is not connected to anything.

Here is a critical piece of info an antenna builder must know: Radio frequency current does NOT travel at the speed of light on the center conductor of coax cables. Due to the properties of the insulating material around the center conductor and the magnetic fields being held inside by the outer shield, electrons travel up to 1/3 slower in coax versus a wire in free air. Therefore a new variable, called Velocity Factor (VF), must be applied to the wavelength

equation to determine the electrical resonant length of a coax cable.

RG-58, with a solid polypropylene insulated center conductor, is the most common form of 50-ohm coax cable. Its Velocity Factor is 0.667, meaning the speed of electrons in this cable is 1/3 slower than the speed of light. Coax cable using foam-type insulation has a VF of around 0.8, thus almost 1/4 slower.

But, allow me to confuse you even more. We DON'T have to worry about VF when determining the length of the Pawsey stub! Why? Because only the shield of the balun is being used, not the center conductor, thus this length of coax acts the same as a conductor in free air where the induced magnetic field extends out into space, thus no VF correction needed!

So why not just use a length of wire instead of coax? Because diameters of conductors play an important role at RF frequencies and the Pawsey stub design requires a diameter equal

to that feeding the antenna elements. Scrap coax meets that condition.

#### **PART 4 THE PAWSEY STUB BALUN**

##### **Step 1**

Cut a length of RG-58 coax cable 23 5/8" long.

##### **Step 2**

Cut a 3/16 inch square **notch** in the outer jacket at each end.

##### **Step 3**

Twist together the exposed strands of the braided shield at each end, apply flux, and tin with solder to create little "pigtailed."

##### **Step 4**

Connect your RG-58 antenna cable to the BNC jack on the antenna block.



Figure 13 – Connecting a wire loop "pigtail" on one end of the Pawsey Stub to the center conductor antenna terminal. Shown before securing with washer and nut.

##### **Step 5**

Solder a 1/2 inch length of copper wire to the "pigtail" made in Step 3 at one end of the Pawsey Stub. Make a loop in the wire and put it under the antenna terminal's nut and washer that is connected to the **center conductor** of the BNC jack (Figure 13).

##### **Step 6**

Tape the Pawsey stub to the radio's coax cable with electrical tape as close as possible to the

BNC connector. Mount the antenna to your aircraft in a VERTICAL orientation. Figure 14 shows how a 3/4 inch wide L-bracket is used to fasten the antenna block to an ultralight's main boom/keel tube.

With the antenna mounted, you are now able to determine exactly where the other end of the Pawsey stub needs to be connected to the shield of the radio's coax cable.



Figure 14 – Antenna mounting example using an L-bracket. Anything similar will work as well.

Tape the stub to the feed coax at its middle and opposite end, making sure there are no gaps between the stub and the coax along the stub's length.

##### **Step 7**

At the point where the stub's "pigtail" touches the coax cable's jacket, cut a 1/4 inch square "window" in the jacket to expose its shield braid. DO NOT cut through the shield! (Figure 15)



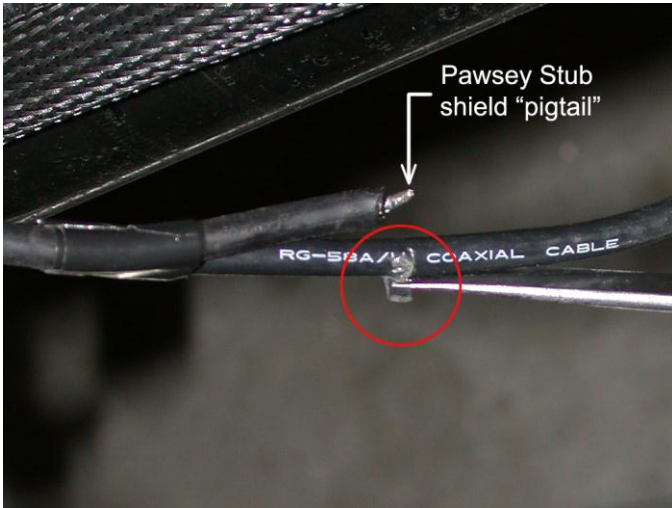

Figure 15 – Red circle shows how a little ‘window’ has been cut in the radio’s coax jacket where the Pawsey Stub ends. Scissors are about to cut the flap off.

**Step 8**

Apply a small bead of solder to the shield exposed in the window. Use heat sparingly to avoid melting the center conductor’s insulation underneath. Put the stub’s pigtail on top of the soldered braid and reheat the joint so the solder reflows, joining the stub’s “pigtail” to the shield of the radio’s coax cable (Figure 16).

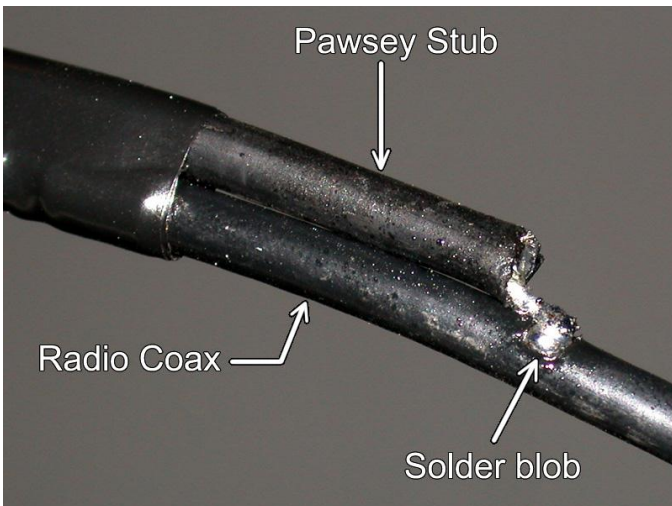

Figure 16 – Applying a dab of solder first to the shield of the radio’s coax, then reheating to reflow the solder into the Stub’s pigtail.

**Step 9**

Spiral wrap the whole length of the Stub and coax with a single layer of electrical tape (Figure 17).

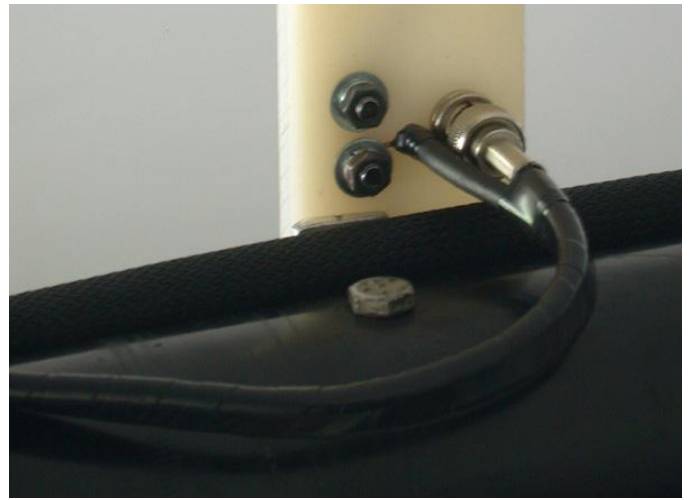

Figure 17 – Spiral wrapped Pawsey Stub.

**GO FLY AND BE HEARD!**

This completes the construction and assembly of your new antenna!

Figure 18 shows the finished “Inverted V” antenna mounted on the author’s Weedhopper™ ultralight.

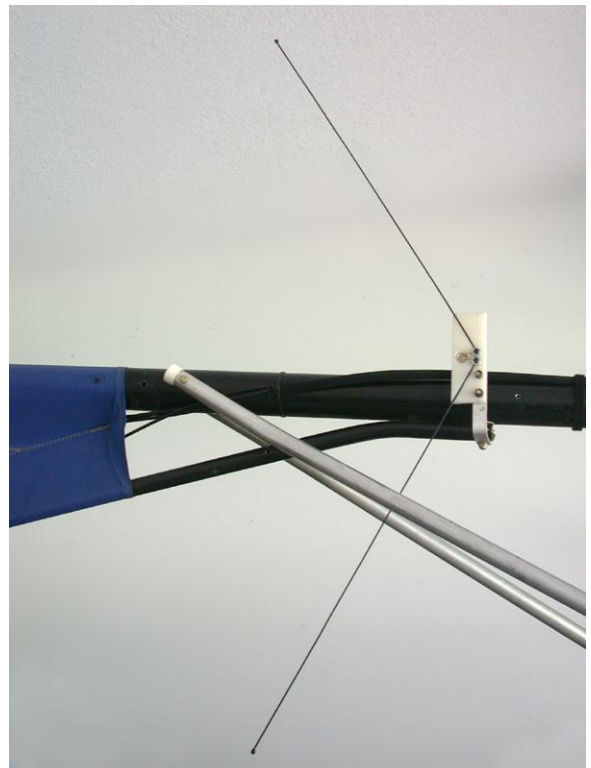

Figure 18 – Overall view of how the author’s antenna is mounted to the boom of his Weedhopper™ Ultralight.

When this antenna is oriented vertically as shown, you get the best near-omni-directional



coverage possible as shown in the radiation pattern plotted in Figure 19. As you can see, it is shaped like a “crumpled donut” instead of a round ball (a ball would represent equal reception and transmission in all directions).

This “crumpled donut” shows that the antenna is about 60 times (-17 dB) **less** sensitive straight up and down and around 5 times (+7 dB) **more** sensitive out toward the horizon in all directions.

Theoretically, aircraft directly above and ground stations directly below you will not receive a very strong signal when you transmit and conversely you won't receive a very strong signal from them, either. Your best reception

and transmission is going to be toward the horizon, where 99% of all the planes and ground stations live anyway. The only thing left to do now is go out and fly and see if this antenna improves your reception and if others can more clearly hear you and farther away.

- - -

Dean Scott is a hobbyist in many general areas like electronics, which he blames on his dad who was a HAM operator. Professionally, he is an award-winning 3D animation artist and graphic designer with an MFA in 3D Computer Art. Of course, none of this qualifies him as an expert on the subject of this article, but it was fun doing it anyway and hope it helps someone out there.

Contact the author via email with questions and/or comments at: [dascott@chrusion.com](mailto:dascott@chrusion.com)

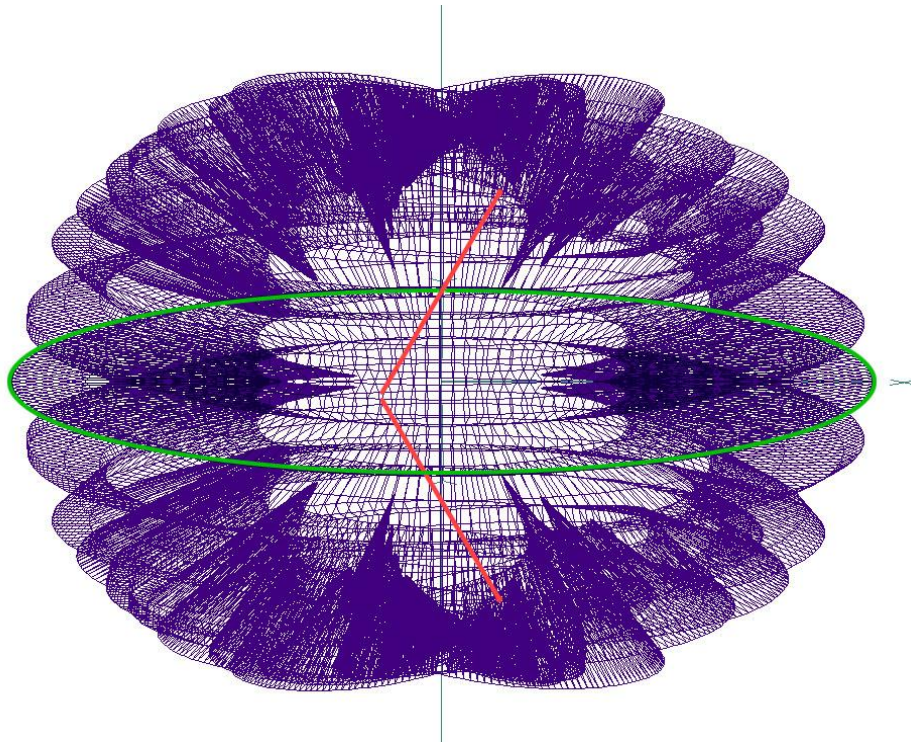

Figure 19 – 3D representation of the “crumpled donut-like” field strength surrounding the red vertically mounted antenna. The green circle represents the horizon where signal strength is at maximum, just what a pilot wants... 360 degree coverage. Notice the puckered top and bottom “poles.” This indicates lower signal receive and transmit strength. Diagram generated by EZNEC 4.0 software on a PC.